

Parking Standards

Draft Supplementary Planning Document
August 2022



Contents

1. Introduction

Page 5

Introduction
Relationship with Local and National Policy
Relationship of SPD to existing Planning Consents, Briefs and Design Codes
The Development of these Standards
Milton Keynes Context
Approach of these Standards
The Zones

2. Vehicle Parking Standards

Page 11

Introduction
Parking for Electric Vehicles
Parking for People with Disabilities
Parking for Powered Two Wheelers
Parking for Goods Vehicles
Drop off and Loading Areas
How to use the Tables
Build to Rent
Car Clubs
Houses in Multiple Occupation

3. Cycle Parking Standards

Page 23

4. Parking for Residential Uses

Page 30

Introduction
Car Parking Locations
On Plot Parking
Drive Throughs
On-Plot Parking to the Front
Tandem Parking
Carports
Parking Options Where No Direct Access Is Permitted
Rear Street/Mews with Flat over Parking Units
Parking Courts
Front Parking Courts
Rear Parking Courts
On Street Parking

'Parking Streets'
Public Squares
Central Reservations

5. Parking for Non-Residential Uses **Page 44**

6. Cycle Parking Design **Page 45**

7. Other Vehicles and Parking Layout **Page 46**

Powered Two-wheelers
Size of Parking Spaces
Layout for standard car parking bays
Layouts for Service vehicles and HGVs

Tables

Table 1 – Electric Vehicle Parking Standards.....	11
Table 2 – Vehicle Parking Standards.....	15
Table 3 – Cycle Parking Standards.....	25
Table 4 – Parking standards for powered two wheelers.....	46
Table 5 – Design standards for delivery and service vehicles.....	51

Figures

Figure 1 - Best practice examples of bike storage facilities.....	24
Figure 2 - Drive-through Parking Within Rear Garden.....	32
Figure 3a - On-Plot Parking Options.....	33
Figure 3b - More On-Plot Parking Options.....	35
Figure 4 - Rear Street/mews with Flat over Parking.....	36
Figure 5 - Front Parking Courts.....	37
Figure 6 - Illustration for Rear Parking Courts.....	39
Figure 7 - Parallel Parking Arrangement.....	40
Figure 8 - Parking Streets.....	41
Figure 9 - Public Squares.....	42
Figure 10 - Parking at Central Reservations.....	42

Diagrams

Diagram 1 – Standard Parking Space.....	48
Diagram 2 – Space adjoining a wall / fence.....	48

Diagram 3 – Parking Space adjoining a dwelling / garage.....48
Diagram 4 – Parking Space adjoining a dwelling / garage.....49
Diagram 5 – Off-Street parking for people with disabilities.....49
Diagram 6 – On-Street parking parallel to a kerb for people with disabilities.....50

Appendices

Appendix A – Maps of Parking Standards Zones.....52
Appendix B – Guidance Note: Implementing Car Clubs in New Development.....66
Appendix C – Guidance Note: Electric Vehicle Charging and Parking.....68

1. Introduction

Introduction

- 1.1 This document sets out the development-related parking standards for Milton Keynes. These standards include requirements for cycles and powered two wheelers. Guidance for the provision of parking for people with disabilities is also included. In addition, it contains guidance on parking for electric vehicles and provision of car clubs.
- 1.2 Work on this Supplementary Planning Document (SPD) started in early 2020 but was paused due to the COVID-19 pandemic. This document should be read together with policies detailed below. Preparations restarted in 2021 and has continued, resulting in this draft document ready for public consultation.
- 1.3 These standards will replace those adopted in January 2016. For clarity, these standards are the number of parking spaces that new developments should provide. For Central Milton Keynes (CMK) and Campbell Park (Zone 1 in the SPD), the vehicle parking standards are set out in Table 3. Given adoption of Plan:MK and production of this SPD after adoption of the CMK Business Neighbourhood Plan, we consider that this 2022 SPD fully supersedes the standards in the Neighbourhood Plan.
- 1.4 Table 1 of this SPD includes a set of parking standards for Zone 1. The Zone 1 standards provide guidance for uses on which the Business Neighbourhood Plan is silent and would be applicable to other locations were they to be redesignated as Zone 1.
- 1.5 This document incorporates an update of relevant aspects of Milton Keynes Council's New Residential Development Design Guide (2012) Supplementary Planning Document (SPD) in order to provide a single source of information to inform parking provision in Milton Keynes. Whilst the New Residential Development Design Guide remains valid, elements relating to parking have been superseded by this document. Where there are discrepancies, this Parking Standards SPD will form the basis for determining planning applications from a parking perspective.
- 1.6 Consultation on this document is programmed to be undertaken from 10 August 2022 until 05 October 2022.

Relationship with Local and National Policy

- 1.7 National planning policy is provided by the National Planning Policy Framework (NPPF) (2021) whilst guidance is provided by National Planning Practice Guidance (NPPG). Paragraph 107 of

the NPPF sets out the Government's approach to car parking standards stating that in setting local standards, local planning authorities should consider the accessibility of the development, the type, mix and use of the development, the availability of and opportunities for public transport, local car ownership levels, and the need to ensure an adequate provision of spaces for charging plug-in and other ultra-low emission vehicles.

1.8 Developments are expected to meet the standards in this SPD. However, proposals will be considered on their merits having regard to local circumstances and the needs of the specific development. Policy CT10 in Plan:MK does allow, where mitigating circumstances apply, for lower than standard parking provision.

1.9 At the time of writing this draft SPD, local policy is provided by the Development Plan, comprising Plan:MK (2019); 18 Neighbourhood Plans; the Waste Development Plan Document (DPD) (2007); Site Allocations Plan (2018); and the Minerals Local Plan (2017). Plan:MK, the Waste DPD and the Minerals Local Plan provide a mix of strategic and non-strategic planning policies while other more detailed policies are provided by the Site Allocations Plan, Neighbourhood Plans and Supplementary Planning Documents.

1.10 Relevant policies included in Plan:MK include CT6 and CT10 which seek the provision of attractive and safe parking areas that are accessible to pedestrians and cyclists, as well as supporting electric vehicle parking.

Relationship of SPD to existing Planning Consents, Briefs and Design Codes

1.11 Extant planning permissions and reserved matters approved prior to the adoption of this SPD, can be implemented as approved. The council would however always entertain re-submitted applications that accord more closely with the principles and guidance contained within this new SPD.

1.12 For some sites, planning permission has been granted subject to legal agreements and planning conditions which require developers to submit future reserved matters applications in accordance with approved pre-existing design codes. Where applications for reserved matters come forward in these areas, the Council will expect developers to follow the requirement of those pre-existing design codes but acknowledge that in submitting reserved matters applications, they may wish to incorporate the principles and guidance contained in this new SPD. Where the reserved matters application is supportive of the content of the SPD, the Council will not refuse the application solely on the basis that it varies from any of the pre-existing approved design codes, especially when the application is seeking to incorporate the principles contained in this SPD.

1.13 Planning Applications, Reserved Matters Applications (not linked to a legal agreement or conditional upon adherence to a design code) and other forms of design guidance (e.g. design codes) submitted after the adoption of this SPD will need to have been prepared, wherever possible and/or appropriate, in accordance with the content of this SPD. All planning applications and other forms of design guidance either submitted but not determined prior to and submitted after the adoption of this SPD will be considered against the content of this SPD.

1.14 The above does not negate the need for formal consents or variations to existing legal agreements.

The Development of these Standards

1.15 In order to inform this SPD, the Council has undertaken a review which has included the following:

- Consideration of existing parking situation in Milton Keynes, including the likely impact of existing and recent car parking standards;
- Consideration of the standards adopted by other local authorities with similar characteristics to Milton Keynes;
- Consideration of best practice guidance on car club provision and electric vehicle charging.
- Assessment of the accessibility of public transport within the authority and opportunities for residents to travel to employment and services without the use of a car.
- How the standards can be future proofed to work with any future changes to the Town and Country Planning (Use Classes) Order 1987 (as amended).

1.16 The design of the city of Milton Keynes has resulted in a low-density environment that tends to favour travel by car. Use of walking, cycling and public transport is comparatively lower, partly due to the large amount of parking at destinations. Car ownership in Milton Keynes is higher than the national average. However, in line with the Council's aspirations to encourage a modal shift toward increased public transport use and active travel, this document provides greater detail on the mitigating circumstances which may justify lower than standard parking provision.

Approach of these Standards

1.17 It is widely recognised that the availability of car parking has a major influence on the means of transport people choose for their journeys. It is therefore essential to try and get the balance right, to encourage the shared use of parking where appropriate and not to create perverse incentives for development to locate away from urban centres. This guidance recognises that Milton Keynes is an authority of contrasts, which produces varying demand for travel, car use,

and its resultant parking requirements. It would therefore be inappropriate to apply a single standard across the entire authority and a zone-based approach will therefore be continued.

1.18 The outcome of the review is that the basis of the existing geographical zones should be amended to a five-zone approach, based on changing local public transport accessibility. Further detail on these changes is provided below.

1.19 In line with paragraph 8 of the NPPF, it is acknowledged there is a need to reflect local circumstances, context and requirements of individual developments when assessing applications. Additionally, paragraph 008 in the Planning Practice Guidance¹ advises that supplementary planning documents should be used to provide more detailed advice or guidance on the policies in an adopted local plan and should not add unnecessarily to the financial burdens on development.

1.20 However, where an applicant chooses to provide more or less parking than the standard, this would need to be subject to a rigorous assessment. It should be clear that flexibility under certain circumstances is not a licence for providing significantly more or significantly less parking provision than indicated within this document. It does however allow a degree of flexibility for locations where a departure from the standard may be warranted but may otherwise be prevented by the application of a geographical standard in an arbitrary manner.

1.21 In cases where a proposal departs from the parking standards, either the Design and Access Statement, or the Transport Statement/Assessment when required by our Highway Guide², shall be expected to include the following items:

- Surveys of parking capacity and occupancy levels on surrounding streets and parking areas; and
- Consideration of likely trip generation and parking accumulations for the proposed development evidenced as appropriate; and
- Details of how the parking will be managed and how that will mitigate any under or over-provision.

1.22 The above is by no means intended as an exhaustive list and in cases where an applicant is considering a departure from the standards, the Council would encourage them to discuss this with its Highways Development Control officers in the first instance.

1.23 In addition, a Travel Plan detailing appropriate measures will be put in place to encourage sustainable travel and future improvements in public transport networks, particularly the provision of high frequency bus routes.

¹ [Plan-making - GOV.UK \(www.gov.uk\)](http://www.gov.uk)

² [A Highway Guide for Milton Keynes 2018](#)

- 1.24 The Council will subsequently secure this using a legal agreement and enforce this as appropriate through the planning process. Measures may include, for example, a car club and membership for a specified period, sustainable travel vouchers, and welcome packs, although the final package of measures should be tailored to the development and site in question. This approach is consistent with Policy CT10 in Plan:MK.
- 1.25 In order to meet the aims of the Council's Mobility Strategy (2018) and Plan:MK, it would be inappropriate to allow excessive parking beyond the standards indicated as this is likely to lead to increased car use and therefore work contrary to the promotion of sustainable modes. Where the need for additional parking beyond the standard has not been justified and/or the Council deem that it will have a significant impact on sustainable travel, land use or town centre retail and employment, it will not be accepted.
- 1.26 Conversely, reductions in parking must consider local circumstances and the requirements of individual developments. Mixed use leisure / retail sites for example may justify a reduction in parking than would be the case if the standards for individual uses are aggregated. This would reflect a certain amount of trip linking, though account would need to be taken of the longer duration of stay compared to that for a single use. Where mixed use developments also include an element of residential development, there may also be potential for sharing of spaces as demand for different uses can peak at different times.
- 1.27 Contributions towards the provision of high-quality public transport will be expected to complement any agreed reduction in parking provision. Contributions to improve walking and cycling will be sought at all locations. Where a reduction in parking below the standard is likely to transfer parking to other locations, development would be considered unacceptable unless it can be demonstrated that those other locations have a clear surplus of parking space.

The Zones

- 1.28 As mentioned above, these standards adopt a five-zone approach, rather than the four-zone approach used in the 2016 Parking Standards SPD. The basis for this change has been a review of public transport accessibility throughout the borough, with areas benefitting from better accessibility being placed in zones benefitting from lower parking requirements. Note that some areas are not placed in an accessibility zone because they are, as yet, undeveloped. The parking requirement in these areas will be agreed when detailed planning applications for their development are submitted for approval, based on an assessment of public transport and active travel accessibility, development density and wider placemaking objectives as set out in Policies SD1, SD9, SD10, SD11, SD12, SD14, HN1, ER9, D1 and D2 of Plan:MK, as relevant to the proposal.

1.29 The Council has identified five zones as follows:

- Zone 1 – Central Milton Keynes and Campbell Park
- Zone 2 – Central Bletchley and Wolverton
- Zone 3 – The district centres of Westcroft and Kingston, and the older town centres of Fenny Stratford, Stony Stratford and Newport Pagnell.
- Zone 4 – The rest of the urban area of the city of Milton Keynes.
- Zone 5 – The rest of the Milton Keynes Council area, which is largely the rural areas.
- To be Decided at Application Stage – South of Milton Keynes Strategic Employment Allocation, South East Milton Keynes Strategic Urban Extension and the Milton Keynes East Strategic Urban Extension.

1.30 As stated in paragraphs 1.3 above, the parking standards set out in this SPD for CMK and Campbell Park are considered to supersede those set out in the CMK Business Neighbourhood Plan.

1.31 The Zone 1 standards provide guidance for uses on which the CMK Business Neighbourhood Plan is silent and would be applicable to other locations were they to be re-designated as Zone 1.

1.32 Zone 1 has the highest level of access to facilities and consequently the lowest parking requirements.

1.33 Zones 4 and 5 have higher parking requirements.

1.34 Plans of the zones are provided within Appendix A.

2. Vehicle Parking Standards

Introduction

2.1 Tables 2 and 3 show the Council’s car parking standard for each of the main land uses.

2.2 These should be applied with the guidance outlined in the previous section and the design guidance provided in Section 4 and Section 5 in mind.

Parking for Electric Vehicles

2.3 Supporting the uptake of alternative fuel vehicles is a key policy aim of the Council and consistent with its participation in flagship schemes such as the Government’s ‘Plugged in Places’ initiative.

2.4 Table 1 below sets out parking standards for electric vehicles.

Type of development	Parking Standard
Residential dwellings	1 active EV charge point per dwelling
Residential apartment buildings with more than 10 associated parking spaces	1 active EV charge point per dwelling, plus passive charging provision for all remaining parking spaces.
Non-residential buildings, residential institutions, secure residential institutions and hotels with more than 10 parking spaces	10% of spaces to have access to an electric vehicle charge point (Active Provision), with at least 1 active charge point, and a further 10% to have passive provision.

2.5 Active provision for electric vehicles: A socket or equivalent connected to the electrical supply system that vehicle owners can use to recharge their vehicle.

2.6 Passive provision for electric vehicles: The network of cable routes and power supply necessary so that at a future date a socket or equivalent can be added easily to allow vehicle owners to recharge their vehicle.

2.7 In order to ensure that all new developments are equipped with the infrastructure required by the growing number of electric vehicles and the Council’s aspirations for future electric vehicle ownership, all developments will be expected to provide charging points at a percentage of the full standard. Numbers in excess of this and/or passive provision, such as ducting and underground servicing which allows additional charging points to be easily installed in future, would be welcomed. Moreover, reflecting our latest evidence on provision of electric vehicle parking and infrastructure provision, we expect new developments to follow the detailed guidance in Appendix C. These standards should be read in conjunction with those in Approved

Document Part S of Schedule 1 (Infrastructure for the charging of electric vehicles) to the Building Regulations 2010.

- 2.8 Please note, that electric vehicle parking will typically be counted as part of the standards provided in Table 2 and not in addition to. It is acknowledged that many current owners of electric vehicles will choose to have two vehicles to provide for different journey types. However, this will become less necessary as technology develops whilst the standards outlined already allow for the ownership of multiple vehicles by residents.
- 2.9 Where appropriate, details of how electric vehicle parking will be allocated and managed should be included within Transport Assessments and a Parking Assessment/Plan. For details of when Transport Assessments and Parking Assessments/Plans will be required to support planning applications, see our Local Validation List³.

Parking for People with Disabilities

- 2.10 It is important that parking at new developments is accessible for blue badge holders. Section 7 of this SPD includes the Council's preferred layout for compliant parking spaces together with guidance on location.
- 2.11 In accordance with Government guidelines⁴, new developments will be expected to ensure that 5% of provision (for both employees and visitors) for employment use classes (3) is suitable for blue badge holders. For all other non-residential use classes a minimum of 6% of total capacity for visitors should be suitable for blue badge holders.
- 2.12 In appropriate developments and locations, it may be appropriate to consider the need for provision of secure and covered parking for mobility scooters.

Parking for Powered Two Wheelers

- 2.13 Powered two wheelers (i.e., motorcycles, mopeds etc.) have reduced land space and road space requirements when compared to other motor vehicles as well as lower fuel consumption. As such, in accordance with the Council's Mobility Strategy, these parking standards support the introduction of parking for powered two wheelers as part of new developments.
- 2.14 The Council's current Mobility Strategy (2018) does not establish an overall mode share target for powered two wheelers or indeed for other modes. However, parking at a percentage of the full standard provided for cars (and minimum of one) covers current use levels and allows for the growth encouraged through the Mobility Strategy. It also compares favourably with the standards adopted by other comparable authorities and is consistent with guidance issued by the Institute of Highway Engineers.

³ [Make a planning application | Milton Keynes Council \(milton-keynes.gov.uk\)](https://www.milton-keynes.gov.uk)

⁴ [Inclusive mobility: making transport accessible for passengers and pedestrians - GOV.UK \(www.gov.uk\)](https://www.gov.uk)

- 2.15 It may be appropriate however for higher levels of provision at uses where the use of powered two wheelers can reasonably be expected to be higher than other uses, for example colleges. Such a need will be assessed through consideration of trip generation forecasts submitted by an applicant.
- 2.16 Where possible, parking should allow powered two wheelers to be secured and preferably be covered. Similarly, facilities for the storage of helmets and other equipment should be considered. Further guidance in this respect is provided in Section 6.

Parking for Goods Vehicles

- 2.17 Certain uses will be frequently serviced by larger vehicles including Heavy Goods Vehicles (HGVs). Where this is the case, parking / loading / standing areas should be provided. Given the range of development this could include, each application will be assessed on its own merits. Guideline figures are however provided within the following tables for Business, Industrial and Storage and Distribution uses.
- 2.18 Where appropriate, it will be necessary to demonstrate through Transport Statements / Transport Assessments or separate Delivery and Servicing Management Plans how goods vehicles will be managed as part of the proposed development, where these vehicles enter a site, they will be expected to enter and leave in forward gear.

Drop off and Loading Areas

- 2.19 Parking for coaches to set passengers down and pick them up will be considered appropriate and necessary for certain uses and developments, most notably those which are leisure related. However, this requirement will be reasonably unique to each site and therefore will be considered on a case-by-case basis.

How to Use the Tables

- 2.20 When applying the standards contained within this document, please note:
- All parking levels relate to gross external floor area.
 - FTE refers to Full Time Equivalent Employee;
 - Provision for uses marked “individual assessment” will require their own justification and completion of the assessments/implementation of strategies referred to in Paragraph 1.20.
 - Levels of parking per member of staff (full time equivalent) should be calculated using the average of those employed on site at any one time.
 - Where it is calculated that part of a space is required, this should be rounded up.

Development Type	Accessibility Zone				
	Zone 1	Zone 2	Zone 3	Zone 4	Zone 5
	<p>Vehicle Parking Standards For developments falling within the E and Sui Generis use classes, provision of parking for goods vehicles will be considered at the design stage and each case will be considered on its merits. For all relevant uses, parking for coaches will also be assessed on a case by case basis.</p>				
General industrial (m2)	Not appropriate in this location	1 per 100 m2 + office element as per B1 + 1.0 HGVS per 300 m2 or min 1	1 per 100 m2 + office element as per B1 + 1.0 HGVS per 300 m2 or min 1	1 per 60 m2 + office element as per B1 + 1.0 HGVS per 300 m2 or min 1	1 per 60 m2 + office element as per B1 + 1.0 HGVS per 300 m2 or min 1
Storage and distribution (m2)	Not appropriate in this location	1 per 166 m2 + office element as per B1 + 1.0 HGVS per 300 m2 or min 1	1 per 166 m2 + office element as per B1 + 1.0 HGVS per 300 m2 or min 1	1 per 100 m2 + office element as per B1 + 1.0 HGVS per 300 m2 or min 1	1 per 100 m2 + office element as per B1 + 1.0 HGVS per 300 m2 or min 1
Hotels	1 per 3 bedrooms + 1 per 33 m ² dining area + any other relevant standards based on proposed uses	1 per 2 bedrooms + 1 per 3m ² dining area+ any other relevant standards based on proposed uses	1 per 2 bedrooms + 1 per 3m ² dining area + any other relevant standards based on proposed uses	1 per 2 bedrooms + 1 per 3m ² dining area + any other relevant standards based on proposed uses	1 per 1 bedroom + 1 per 2m ² dining area + any other relevant standards based on proposed uses
Residential institutions Care homes	1 per 6 beds or most appropriate E(e) or E(f) standard	Assessed on a case by case basis subject to forecast number of car owning residents which will be based on the level of care offered. Institutions marketed to able bodied people (e.g. over 60s) will be expected to provide parking at a rate of 1/8 bedrooms in Zones 1-2 and 1/4 in Zones 3-4. All institutions should provide visitor parking at a rate of 1/6 bedrooms in Zones 1-2 and 1/4 bedrooms in Zones 3-4 and one for every resident warden.			

Secure residential institutions	Owing to the different types of institution which could fall into this category and the potential differences between new-builds and extensions, development will be considered case by case.				
Student Accommodation	1 per 3 staff	1 per 6 students where linked to Travel Plan measures + 1 per 2 staff	1 per 6 students where linked to Travel Plan measures + 1 per 2 staff	Assessed on merit – central locations easily accessible to University Campus MK likely to be more sustainable in encouraging sustainable travel 1/4 students + 1 per staff	Not suitable in this location.
Hospital (in patients)	1 per 6 FTE staff + 1 per 5 beds	1 per 6 FTE staff + 1 per 4 beds	1 per 6 FTE staff + 1 per 4 beds	1 per 4 FTE staff + 1 per 3 beds	1 per 4 FTE staff + 1 per 3 beds
Hospital (outpatients)	1 per 6 FTE staff + 1 per consulting room	1 per 6 FTE staff + 1 per consulting room	1 per 6 FTE staff + 1 per consulting room	1 per 4 FTE staff + 1 per 1 consulting room	1 per 4 FTE staff + 1 per 1 consulting room
Residential dwellings (per unit)	1	1+0.33 unallocated	1+0.33 unallocated	1+0.33 unallocated	1+0.33 unallocated
1-bedroom dwellings					
2-bedroom flat	1	1+0.33 unallocated	1+0.33 unallocated	1+0.75 unallocated	1+0.75 unallocated
2-bedroom dwellings	1	1+0.33 unallocated	1+0.33 unallocated	2+0.25 unallocated	2+0.25 unallocated
3-bedroom dwellings	2	2+0.33 unallocated	2+0.33 unallocated	2+0.5 unallocated	2+0.5 unallocated
4+ bedroom dwellings	2	2+0.33 unallocated	2+0.33 unallocated	2+0.5 unallocated	3+0.33 unallocated
Build to Rent (spaces per unit)	0.33	0.33	N/A	N/A	N/A
1 bed					
2 bed	0.5	0.5	N/A	N/A	N/A
3 bed	0.75	0.75	N/A	N/A	N/A
4 bed	1	1	N/A	N/A	N/A
Unallocated parking for Build to Rent (visitor & staff)	0	0.25	N/A	N/A	N/A

Houses in multiple occupation (HMOs)	Car free, except where lettable rooms are proposed to be designed for disabled access, parking at a 1:1 ratio should be provided per disabled access room.	0.33 per lettable room	0.5 per lettable room	0.66 per lettable room	0.75 per lettable room
Display or retail sale of goods, other than hot food: food	1 per 46 m ²	1 per 23 m ²	1 per 23 m ²	1 per 14 m ²	1 per 14 m ²
Display or retail sale of goods, other than hot food: non-food	1 per 66 m ²	1 per 33 m ²	1 per 33 m ²	1 per 20 m ²	1 per 20 m ²
Sale of food and drink for consumption (mostly) on the premises. For larger developments of this type, applicants should discuss parking requirements with Highways Development Management officers at an early stage.	1 per 33 m ²	1 per 3 m ²	1 per 3 m ²	1 per 2 m ²	1 per 2 m ²
Provision of financial services, Professional services (other than health of medical services), or Other appropriate services in a commercial, business or service locality.	1 per 66 m ²	1 per 33 m ²	1 per 33 m ²	1 per 20 m ²	1 per 20 m ²
Indoor sport, recreation or fitness (not involving motorised vehicles or firearms)	1 per 20 m ² public area	1 per 15 m ² public area	1 per 15 m ² public area	1 per 10 m ² public area	1 per 10 m ² public area

Provision of medical or health services (except the use of premises attached to the residence of the consultant or practitioner)	3 per 1 consulting room	3 per 1 consulting room	3 per 1 consulting room	4 per 1 consulting room	5 per 1 consulting room
Creche, day nursery or day centre (not including a residential use)	1 per 3 FTE staff + 1 drop off space per 6 children	1 per 2 FTE staff + 1 drop off space per 6 children	1 per 2 FTE staff + 1 drop off space per 6 children	1 per 1 FTE staff + 1 drop off space per 4 children	1 per 1 FTE staff + 1 drop off space per 4 children
	To avoid the unnecessary profligate use of land, alternative parking at neighbouring sites will be considered as contributing towards the required drop-off provision. However, for a nursery this will need to be within 100m of the site.				
Uses which can be carried out in a residential area without detriment to its amenity: Offices to carry out any operational or administrative functions, Research and development of products or processes, Industrial processes	1 per 50 m ²	1 per 50 m ²	1 per 50 m ²	1 per 30 m ²	1 per 30 m ²
	E(g) (i), (ii) and (iii) units over 300 m ² expected to provide one HGV space per 500 m ² or a minimum of one.				
Provision of education Pupil age 4-7 years	1 per 3 FTE staff + 1 drop off space per 9 pupils	1 per 2 FTE staff + 1 drop off space per 9 pupils	1 per 2 FTE staff + 1 drop off space per 9 pupils	1 per 1 FTE staff + 1 drop off space per 6 pupils	1 per 1 FTE staff + 1 drop off space per 6 pupils
Pupil age 8-11 years	1 per 3 FTE staff + 1 drop off space per 12 pupils	1 per 2 FTE staff + 1 drop off space per 12 pupils	1 per 2 FTE staff + 1 drop off space per 12 pupils	1 per 1 FTE staff + 1 drop off space per 8 pupils	1 per 1 FTE staff + 1 drop off space per 8 pupils
Pupil age 4-11 years	1 per 3 FTE staff + 1 drop off space per 12 pupils	1 per 2 FTE staff + 1 drop off space per 12 pupils	1 per 2 FTE staff + 1 drop off space per 12 pupils	1 per 1 FTE staff + 1 drop off space per 8 pupils	1 per 1 FTE staff + 1 drop off space per 8 pupils
Relaxation of the parking standards for drop off spaces for schools might be considered acceptable subject to local circumstances and the car journey reducing measures in an agreed Travel Plan.					

Pupil age 11+ years	1 per FTE 3 staff + 15 drop off spaces for the first 500 children and 30 thereafter	1 per 2 FTE staff + 15 drop off spaces for the first 500 children and 30 thereafter	1 per 2 FTE staff + 15 drop off spaces for the first 500 children and 30 thereafter	1 per 1 FTE staff + 20 drop off spaces for the first 500 children and 30 thereafter	1 per 1 FTE staff + 20 drop off spaces for the first 500 children and 30 thereafter
Further/higher education	1 per 6 FTE staff + 1 per 30 students	1 per 2 FTE staff + 1 per 25 students	1 per 2 FTE staff + 1 per 25 students	1 per 1 FTE staff + 1 per 15 students	1 per 1 FTE staff + 1 per 15 students
Display of works of art (otherwise than for sale or hire), Museums Public libraries or public reading rooms, Public halls or exhibition halls	1 space per 30 m ²				
Public worship or religious instruction (or in connection with such use) Seated Assembly	1 space per 10 m ²	1 space per 10 m ²	1 space per 10 m ²	1 space per 10 m ²	1 space per 10 m ²
Ancillary rooms	1 space per 73 m ²	1 space per 36 m ²	1 space per 36 m ²	1 space per 22 m ²	1 space per 22 m ²
Law courts	Parking provision for proposals for law courts will be assessed on a case by case basis.				
Isolated shops (not exceeding 280 sq. metres), selling essential goods, incl. food & at least 1km from another similar shop	1 per 46 m ²	1 per 23 m ²	1 per 23 m ²	1 per 14 m ²	1 per 14 m ²
Halls or meeting places for the principal use of the local community	1 space per 30 m ²				
Areas or places for outdoor sport or recreation (not involving motorised vehicles or firearms) Sports pitches	20 spaces per sports pitch which includes 2 disabled spaces plus, when seating is provided, 1 space per 10 spectators seats.				

Areas or places for outdoor sport or recreation (not involving motorised vehicles or firearms) Pavilions for outdoor uses	1 per 73 m ² public area as a starting point for assessment, with final provision depending on specifics of proposed use.	1 per 36 m ² public area as a starting point for assessment, with final provision depending on specifics of proposed use.	1 per 36 m ² public area as a starting point for assessment, with final provision depending on specifics of proposed use.	1 per 22 m ² public area as a starting point for assessment, with final provision depending on specifics of proposed use.	1 per 22 m ² public area as a starting point for assessment, with final provision depending on specifics of proposed use.
Indoor or outdoor swimming pools or skating rinks	1 per 30 m ² public area	1 per 15 m ² public area	1 per 15 m ² public area	1 per 10 m ² public area	1 per 10 m ² public area
Theatre	1 per 16 seats	1 per 8 seats	1 per 8 seats	1 per 5 seats	1 per 5 seats
Car Related Uses	Not appropriate in this location.	1 per 12.5 m ² general storage 1 per 100 m ² display areas (internal and external) 3/bay MoT/Tyre/Exhaust	1 per 12.5 m ² general storage 1 per 100 m ² display areas (internal and external) 3/bay MoT/Tyre/Exhaust	1 per 12.5 m ² general storage 1 per 100 m ² display areas (internal and external) 3/bay MoT/Tyre/Exhaust	1 per 12.5 m ² general storage 1 per 100 m ² display areas (internal and external) 3/bay MoT/Tyre/Exhaust
Drinking establishments (bar area m²)	1 per 33 m ²	1 per 2 m ²	1 per 2 m ²	1 per 1.5 m ²	1 per 1.5 m ²
Hot food takeaways (public area m²)	1 per 33 m ²	1 per 2 m ²	1 per 2 m ²	2 per 2.5 m ²	2 per 2.5 m ²
Cinema	1 per 16 seats	1 per 8 seats	1 per 8 seats	1 per 5 seats	1 per 5 seats
Unspecified, including hostels	Due to the variety of uses that can fall within the sui generis definition, it is not possible to provide specific parking standards for every use that could arise. Where sui generis uses are proposed, the parking requirement will be assessed based on the nature of the use and its location.				

Build to Rent

2.21 Build to Rent developments are a specific type of residential development as recognised in the National Planning Policy Framework⁵ and the Planning Practice Guidance⁶. For the purpose of applying the standards in Table 2, Build to Rent is defined as: “New residential supply for market rent in clusters with a single owner using professional management.”

2.22 As Build to Rent schemes tend to be only delivered in high density and highly accessible locations, due to their target demographic and typical business model, and due to lower accessibility levels in the outer zones, we do not expect Build to Rent schemes to come forward in Zones 3-5. Therefore, no standards are provided for Build to Rent in these locations.

2.23 The standards in Table 2 should enable assessment on a case-by-case basis. The following caveats apply:

- Where units are designed to disabled access standards, parking at a 1:1 ratio should be provided per disabled access unit.
- Dedicated loading and servicing facilities should be provided on-site.
- Allocated staff parking may be required where high numbers of on-site staff are proposed. This will be assessed on an individual basis.
- All Build to Rent proposals should incorporate a Travel Plan including robust measures to encourage low car ownership.
- Car-free schemes will be considered within Zone 1, or future areas where on-street parking controls are in place.
- Future residents of car-free schemes would not be eligible for on-street parking permits.
- If parking is proposed below the standard in locations where surrounding on-street parking is uncontrolled, parking beat surveys will be required in accordance with the Lambeth parking methodology.

Car Clubs

2.24 It is also recommended that any scheme with an overall parking ratio of 0.33 or less must provide, or contribute towards, at least 3 pool cars or car club vehicles per 100 units. Publicly accessible car club vehicles are preferred where viable and these should be located in a prominent visible location. In areas with a high concentration of car club vehicles already in the vicinity, this should be assessed on a case-by-case basis. As stated in the Project Centre Topic Paper produced to support this SPD, evidence shows that 1 car club car justifies removal of 6 private parking bays from a development. We will assess proposals on this basis, unless new

⁵ [National Planning Policy Framework - GOV.UK \(www.gov.uk\)](https://www.gov.uk)

⁶ [Build to rent - GOV.UK \(www.gov.uk\)](https://www.gov.uk)

evidence suggests a different ratio is more appropriate. Appendix B provides further guidance on how we expect car clubs to be provided.

Houses in Multiple Occupation

2.25 To enable flexibility in the way in which the vehicle parking standards for Houses in Multiple Occupation (HMOs) are applied, the following caveats apply to proposals for (HMOs):

- Where a proposal is to convert an existing dwelling house to a HMO property, any shortfall in provision from the existing use can be considered when assessing potential on-street impacts of the HMO proposal.
- Where a property proposed for conversion to C4 HMO has existing on-plot parking exceeding the maximum HMO parking standard, it is not considered necessary to remove parking spaces.
- Provision for electric vehicle charging for at least one vehicle should be incorporated where on-plot parking is provided.
- If parking is proposed below the standard, it should be demonstrated that on-street parking can suitably be accommodated without adversely impacting highways safety or capacity.
- If parking is proposed below the standard in areas of high on-street parking pressure or limited on-street space, a parking beat survey is required to support the application.

3. Cycle Parking Standards

- 3.1 The provision of good quality cycle storage is an important means of encouraging more people to cycle and thus reduce pressure on the highway both in terms of congestion and car parking demand.
- 3.2 Section 6 provides further details on what the Council considers to be good practice in cycle parking design and location, including consideration of separate cycle storage for short-term (e.g. visitor) and long-term (e.g. residents, employees) users. This should be read in conjunction with guidance included in LTN 1/20⁷ (2020) or updated versions of this. Long-term cycle parking should benefit from additional security (CCTV and/or secure or non-public access) and shelter from the weather.
- 3.3 The table overleaf provides a summary of the cycle parking standards for each use. Where the standard indicates part of a space is required, this should be rounded up to the nearest whole number. All developments should provide a minimum of one cycle parking space. Where a use is not specified, the cycle parking requirement will be judged on merit.

Paragraph 11.2.6 LTN 1/20

As with car parking, a proportion of the cycle parking (5%) should be provided for non-standard cycles to accommodate people with mobility impairments. Specific areas should be set aside for three-wheel cycles, which are problematic to secure to traditional upright hoops, in the most accessible parts of a large cycle park so that they can be used by disabled people with adapted cycles. Accessible cycle parking should normally also be placed close to accessible car parking spaces. Isolated cycle stands for short-term parking should be configured to bear in mind the length of cargo bikes and tandems, and the width of tricycles and side-by-side cycles.

- 3.4 There is no variation on the cycle parking standard by location. However, if site specific proposals and conditions justify this, the Council may consider a departure from the standard for Zone 5 for non-residential uses. This will however not be routine practice and be subject to justification from the applicant, including other measures that will be implemented to encourage sustainable travel. The Council will not wish to see developments, even in more rural locations, with no cycle parking provision though is prepared to be flexible in order to avoid the provision of large amounts of under-used cycle parking. In all cases, a Travel Plan requirement

⁷ [*Cycle Infrastructure Design \(publishing.service.gov.uk\)](https://www.publishing.service.gov.uk/government/uploads/system/uploads/attachment_data/file/86422/cycle_infrastructure_design.pdf) See Chapter 11 on Cycle Parking and other equipment.

would be added whereby the applicant would be expected to monitor the use of cycle parking and extending this as necessary.

3.5 Facilities for showering and storing clothes will also be sought as they are also important for encouraging cycle use.

3.6 It is acknowledged that younger children travel to school by scooter and as such an allowance has been made for educational establishments to provide scooter parking as part of their allocation as detailed in Table 3.

Figure 1 – Best Practice Examples of Bike Storage Facilities



Table 3: Cycle Parking Standards.			
Use		Casual/Visitor Parking	Employee/Resident Parking
General industrial (m2)		1 space per 500 m ² with a minimum of 2 spaces	1 per 400 m2 or 1 per 10 FTE (whichever is greater) Showers and changing facilities should be provided for all industrial developments of 500m2 and above. Facilities should be provided on the basis to cater for a minimum of 10% of staff
Storage and distribution (m2)		1 space per 1000 m ² with a minimum of 2 spaces	1 per 500 m2 or 1 per 10 FTE staff (whichever is greater) Showers and changing facilities should be provided for all industrial developments of 500m2 and above. Facilities should be provided on the basis to cater for a minimum of 10% of staff.
Hotels		N/A	2 long term spaces per 10 bedrooms. Staff and guest parking should be secure but can be shared if necessary. A bicycles-in bedrooms policy may be acceptable if these are conveniently accessible and staff parking would still be required at a rate of 10%.
Residential institutions - Hospitals		1 per 50m2	1 per 5 FTE staff

Residential institutions - Sheltered/elderly housing / Nursing Homes		1 per 20 beds	1 per 20 beds
Residential institutions - Student Accommodation		N/A	1 per bedroom
		Showers and changing facilities should be provided for all residential institutions of 500m ² and above. Facilities should be provided on the basis to cater for a minimum of 10% of staff.	
Residential dwellings (per unit) 1 or 2 bedrooms		1 space per 20 units	1 per bedroom
3+ bedrooms			
Houses in Multiple Occupation		1 per HMO	1 per bedroom
Display or retail sale of goods, other than hot food: food	Small (<200m ²)	1 per 100 m ²	1 per 100 m ²
	Medium 200-1,000m ²	1 per 200 m ²	1 per 200m ²
Display or retail sale of goods, other than hot food: non-food	Large >1,000m ²	1 per 250m ²	1 per 500m ²
Sale of food and drink for consumption (mostly) on the premises. <i>For larger developments within this use class, applicants should discuss parking requirements with Highways Development Management officers at an early stage.</i>		1 per 50 m ²	1 per 200 m ² or 1 per 10 FTE staff

Provision of financial services, Professional services (other than health or medical services), or Other appropriate services in a commercial, business or service locality.		1 per 100 m ²	1 per 200 m ² or 1 per 10 FTE staff
Indoor sport, recreation or fitness (not involving motorised vehicles or firearms)		Greatest of 1 per 50m ² or 1 per 30 seats /capacity	1 per 5 employees
Provision of medical or health services (except the use of premises attached to the residence of the consultant or practitioner)		1 per consulting room	1 per 10 FTE staff
Creche, day nursery or day centre (not including a residential use)		1 per 10 children	1 per 10 FTE staff
Uses which can be carried out in a residential area without detriment to its amenity: Offices to carry out any operational or administrative functions, Research and development of products or processes Industrial processes		Minimum 2 for visitors and at 1 per 500 m ² thereafter	1 per 120 m ² or 1 per 10 FTE staff
Provision of education Pupil age 4-7 years		1 per year group	1 per 8 Pupils + 1 per 10 FTE Provision for Scooters Parking: 5- 50% of total Cycle spaces
Pupil age 8-11 years			1 per 6 Pupils + 1 per 10 FTE Provision for Scooters Parking: 5- 25% of total Cycle spaces

Pupil age 4-11 years			1 per 7 Pupils + 1 per 10 FTE Provision for Scooters Parking: 5- 25% of total Cycle spaces
Pupil age 11+ years		1 per year group	1 per 10 FTE staff and 1 per 5 students
Further/higher education		1 per 5 students	1 per 5 FTE staff
		Staff and pupil storage should be sited separately	
Display of works of art (otherwise than for sale or hire) Museums Public libraries or public reading rooms Public halls or exhibition halls		1 per 100 m2	1 per 10 FTE staff
Public worship or religious instruction (or in connection with such use)		Each proposal to be judged on a case by case basis, based on site specific factors such as nature of the proposed use and its location.	
Law courts			
Isolated shops (not exceeding 280 sq. metres), selling essential goods, incl. food & at least 1km from another similar shop		1 per 100 m2	1 per 200 m2 or 1 per 10 FTE staff
Halls or meeting places for the principal use of the local community		Greatest of 1 per 50m2 or 1 per 30 seats /capacity	1 per 5 employees
Areas or places for outdoor sport or recreation (not involving motorised vehicles or firearms)		Each proposal to be judged on a case-by-case basis, based on site specific factors such as nature of the proposed use and its location.	
Indoor or outdoor swimming pools or skating rinks		Greatest of 1 per 50m2 or 1 per 30 seats /capacity	1 per 5 employees

Theatre		Each proposal to be judged on a case by case basis, based on site specific factors such as nature of the proposed use and its location.
Car Related Uses		
Drinking establishments (bar area m²)		
Hot food takeaways (public area m²)		
Cinema		
unspecified		

4. Parking for Residential Uses

Introduction

- 4.1 Careful design of road layouts and parking is as key a consideration as the number of spaces provided. Indeed, poor design can effectively reduce the level of parking available. Good parking design can also greatly improve the overall quality and sustainability of a development. Therefore, this section provides details on what the Council expects to see in the design of car and cycle parking including certain minimum criteria that will need to be met in order for a space to be counted as a parking space when assessing an application.
- 4.2 All dwellings, whether shared ownership or market housing, should have access to at least one allocated, independently accessible, off-street parking space.
- 4.3 The information presented largely replicates that included within the Residential Design Guide SPD adopted by the Council in 2012. This Parking Standards SPD however provides consideration of all uses and will take precedence where it is deemed that there is any conflict between the two documents.

Car Parking Locations

- 4.4 Parking has a fundamental influence on the quality of a development, the streetscape in particular, and is a significant factor in the desirability of a place to live. Location of parking is one of the most prominent issues in pre-application discussions.
- Garages do not count as parking spaces;
 - Detached homes with 5+ bedrooms will generally be expected to have at least 2 on-plot, independently accessible parking spaces.
- 4.5 In Milton Keynes, an increasingly common problem associated with new developments (and in particular terraces) is cars parked on verges, on footways and on streets that are not designed to accommodate parked cars. This is partly because car ownership is higher than average in Milton Keynes. More importantly, however, rear courts, which have to date generally been the chosen form of allocated parking (particularly for terraces), have not been well used by residents. This is due to several factors:
- Parking spaces are too remote from the front door;
 - Rear parking court feels unsafe/insecure;
 - Rear gate of garden is not lockable from both sides (hence is often not practical or possible to use);

- No path through rear garden further discourages use;
- Surveillance of the rear parking area blocked by garden fences.

4.6 The result of parking on verges, on footways and on streets that are not designed for on-street parking is:

- Bin lorries and emergency vehicles cannot get through;
- Unsafe streets are created because, for example, sight lines are blocked;
- Cluttered and “untidy” street scenes;
- Verges becoming unsightly, which further undermines the streetscape;
- Footways become impassable, causing a serious obstruction and danger for many people, especially those with mobility and visual impairments.

4.7 Opportunities for inappropriate parking should be designed out of schemes, as far as possible. Providing sufficient designated on-street parking spaces in the right locations will assist in reducing the instances where residents feel the need to park on footways or verges. However, inappropriate parking should also be prevented through the design of the street. A range of street elements, such as carriageway widths, street furniture and planting, (including trees and groundcover planting), can be manipulated to constrain or direct parking.

4.8 For these above reasons, the following hierarchy of preference should be adhered to when providing car parking for new residential developments:

- On plot, located at the front or side of the dwelling;
- On-street to the front of dwellings (either on the street itself or as part of a front parking court).

4.9 Appropriately designed, on-street parking as part of an application will be welcomed by the Council and will be counted towards the number of spaces that a developer is expected to provide for visitors.

4.10 The following sections provide guidance and solutions on how to accommodate parking. Developers should also refer to guidance contained in the National Design Guide⁸, the National Model Design Code Coding Process document⁹ and the National Model Design Code Guidance Notes¹⁰, which endorse parking solutions that balance the need to provide other benefits alongside parking space, such as beauty, green infrastructure and street trees, health and well-being, traffic calming and surface water management. In particular, the visual impact of car parking should be minimised.

⁸ See Paragraphs 77, 85 and 86 [National design guide - GOV.UK \(www.gov.uk\)](https://www.gov.uk)

⁹ See Paragraphs 50 and 59 [National Model Design Code - Part 1 The Coding Process \(publishing.service.gov.uk\)](https://publishing.service.gov.uk)

¹⁰ See Figure 13 and Paragraphs 44, 50 and 131 [National Model Design Code - Part 2 Guidance Notes \(publishing.service.gov.uk\)](https://publishing.service.gov.uk)

On Plot Parking

4.11 On-plot parking can be provided:

- To the side of dwellings
- As a “drive through” to hardstanding within the rear garden; or
- To the front as right-angled and/or parallel parking;

Drive Throughs

4.12 These are in effect car ports but are open at the back to allow parking either within the building and/or within the rear garden. The advantage of drive throughs to hardstanding or garages in the rear garden is that continuity of frontage can be maintained whilst retaining on-plot parking. 1.8-metre-high fencing or walling is required around the parking to provide security to the rear garden. Minimum width should be 3.5m.

4.13 Drive throughs to hard standing within the rear garden can create blank frontages and make ground floor internal layouts less practical, and therefore need to be designed with care. They are best incorporated within wide frontage dwellings, which enables “active rooms”, such as living rooms and kitchens, to still be provided fronting the street at ground floor level.

4.14 Where ‘drive throughs’ are incorporated in narrow frontage dwellings, balconies or bays at first floor level are one useful means of creating interest and activating the frontage. They must have active ground floor frontages on the other side of the street to provide overlooking of the drive through, as demonstrated in Figure 3b.

4.15 For wider frontage properties with wider rear gardens, single vehicle drive throughs could potentially widen within the rear to include hardstanding for independently accessible parking. This is illustrated in Figure 3b.

Figure 2 – Drive through parking within rear garden



On Plot Parking to the Front

4.16 A variation of the on-plot parking solution is the provision of right-angled and/or parallel parking to the front of the dwelling. For terraced houses this will likely occur as right-angled parking behind the back of the adoptable highway (see Figure 3a) while for semi-detached and detached housing a deeper front garden or privacy strip should be included (up to approximately 6-7m) to allow on plot parking to the front of the dwelling as either right angled or parallel parking. In these cases, the parking spaces should be designed into a landscaped privacy strip to avoid the subsequent ad hoc paving over of front gardens (potentially devoid of any landscaping) by homeowners which will undermine the quality of the streetscape but rather ensure that the entire streetscape has been integrally designed from the outset.

Figure 3a – On plot parking options

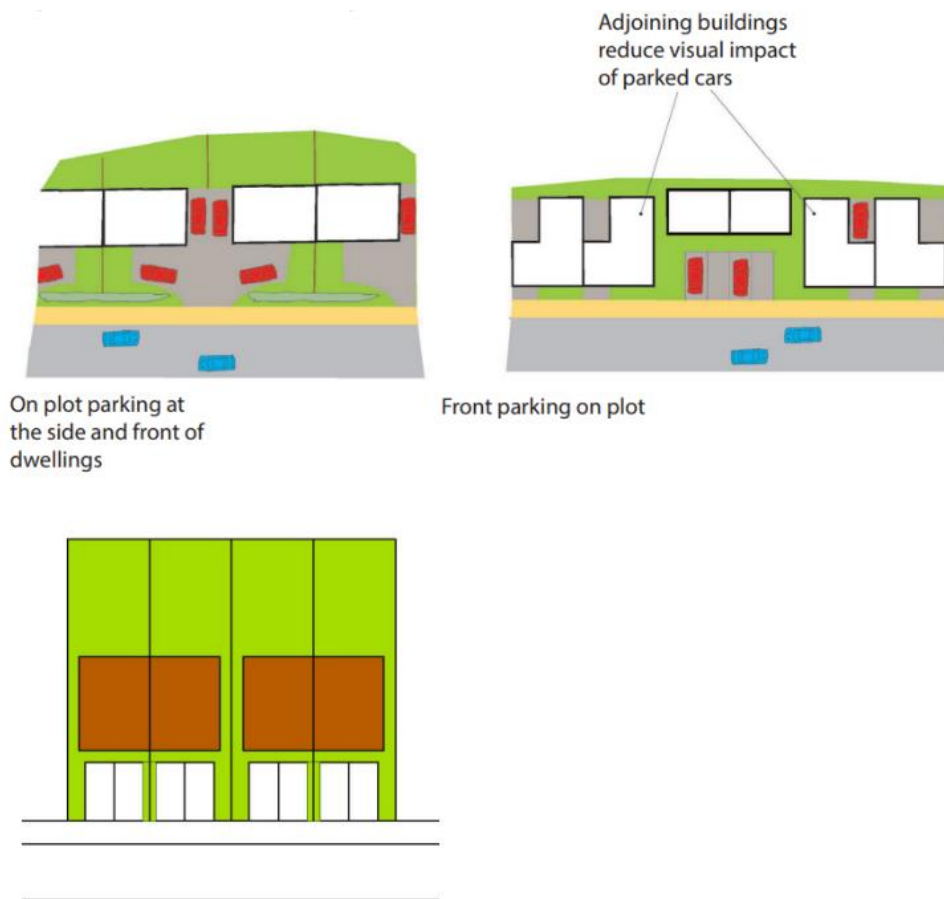

4.17 Independently accessible on-plot parking spaces are preferred. There is a presumption against the provision of tandem parking (or any similar layout where the spaces are not independently accessible). If, however, such a layout is proposed then:

- An additional¹¹, convenient, on-street parking space must be provided at a rate of 1 space per every two dwellings that have tandem parking (or any similar layout where the spaces are not accessed independently);
- The on-street provision must not encroach into the track path of buses on bus routes and other primarily residential streets (type 5-8)¹² so as to allow for the movement of free-flowing traffic, including service delivery vehicles. This requires on-street parking to be provided outside of the established carriageway in these streets.
- For street types 9-12, the required on-street parking can be provided on street but in this case must be clearly laid out/delineated within the carriageway and located so as to allow for the movement of free-flowing traffic, including service delivery vehicles.

4.18 Parking spaces in front of garages must be at least 6 metres long in order to allow access to the garage without a car overhanging the footway.

4.19 The illustrations in Figure 3b show a variety of on plot parking options discussed above. They importantly highlight that there should not be more than 8 properties in a row that are served by right angled parking to the front. This is to ensure that the streetscape does not become dominated by parked cars. A 1m spacing should also be included around a maximum of 8 parking spaces for pedestrian circulation. Street trees as indicated in the illustrations should also be included to soften the streetscape. Beyond the 8 properties in a terrace formation, buildings should come forward to reduce the visual impact of parked cars and provide a more human scaled streetscape.

4.20 In these illustrations, the on street parallel parking must be located subject to safe manoeuvrability from the on-plot parking into the street.

¹¹ For the avoidance of doubt, “additional” means in addition to the usual requirement for unallocated on-street parking spaces. “Convenient” means an on-street space within 15m of the front of a property where tandem parking is provided.

¹² For definition of street types, see [A Highway Guide for Milton Keynes 2018](#)

Figure 3b – More on-plot parking options

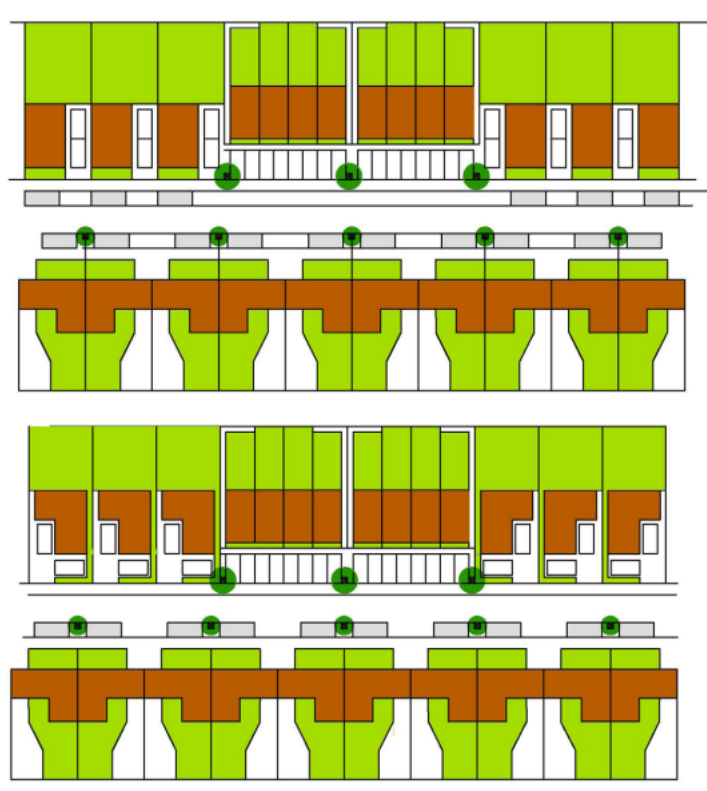

Carports

4.21 There are concerns where carports are accessed from the public realm as they are often poorly overlooked. They should therefore be overlooked by housing from the other side of the street. Carports are required to be open on two faces and to have minimum internal dimensions of 3.0m x 5.0m per space. Where the carport is located to the side of the house, any fence or wall provided to secure the rear garden should be at least 1 metre from the end of the car port. Permitted development rights to erect gates/doors to the front of carports will be withdrawn and, in determining any planning applications, consideration will be given to the amount and location of the remaining car parking space(s).

Parking Options where no Direct Access is Permitted

4.22 Rear parking courts have proved unpopular as parking choices for residents and are therefore not supported as a parking option in Milton Keynes.

4.23 It is not just Milton Keynes Council that does not support the inclusion of rear parking courts. Both Manual for Streets and the Parking Guide “Car Parking: What Works Where” (prepared by the former English Partnerships and now available via the Homes and Communities Agency state that rear court parking is recommended only after parking to the front and on street have been fully considered. Rear courtyards should support on-street parking, not replace it.

4.24 It is however accepted that for certain streets, frontage access for vehicles from the street can't be achieved or is not permitted and alternate parking solutions should be sought.

Rear Street/Mews with Flat over Parking Units

4.25 The below illustration (Figure 4) demonstrates how a street behind the rear of the properties would provide parking for the properties that are not permitted to have access from the front.

4.26 A few Flat over Parking (FOP) units are included along the back boundary of the properties which would help accommodate the required parking for the housing behind them. Other parking would be provided between the FOP units on the rear boundary of the relevant house.

4.27 For this solution to be acceptable housing would be needed on the other side of the street, facing the FOP units for surveillance purposes. The FOP units are also important so that the access route has the character of a street with development facing it on both sides. This street should take on a mews form.

4.28 The Council's Crime Prevention Design Advisor has also stated that these rear streets should also be designed as cul-de-sacs particularly to improve security of the open aspects of the FOP's. A wall with soft planting either side can serve to divide the 2 cul-de-sacs.

Figure 4 - Rear Street/mews with Flat over Parking



Parking Courts

Front Parking Courts

4.29 These are located at the front where people like to park and where parking can be overlooked and be close to front doors, as shown in Figure 5.

Figure 5 - Front parking courts

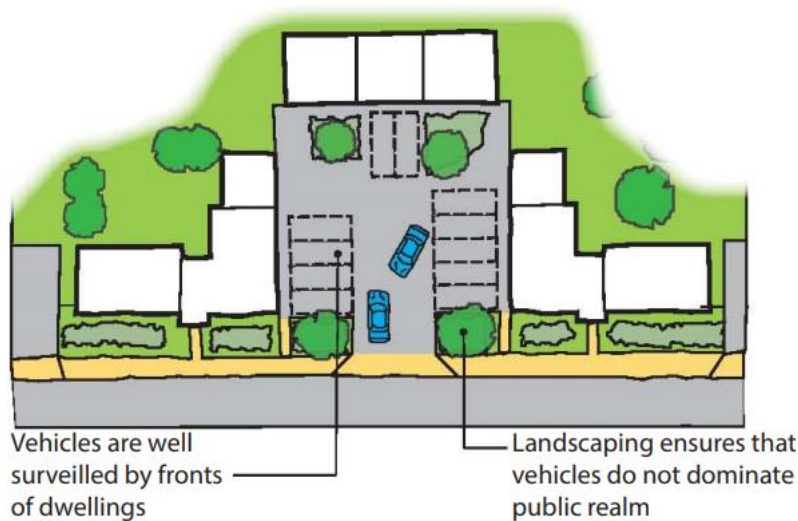

Rear Parking Courts

4.30 If it can be demonstrated that the above parking solution cannot be delivered, small private and secure rear parking courts may therefore be accepted.

4.31 Where rear parking courts are included, it is essential that on street parking is carefully managed. If it is not allowed, then this should be suitably enforced through for example double yellow lines. If it is allowed, parking should be carefully designed into the streetscape so as to avoid indiscriminate parking on verges, pavements or indeed in the carriageway such that it prevents safe through movement of large vehicles.

4.32 Rear parking courts must be made to feel as private and secure as possible. This can be achieved through:

- Well designed 'bridges' between houses;
- Electronic lockable gates (operated by key code so that in case of emergency, the code may be passed to emergency responders);
- As narrow an entrance as possible while still meeting highway requirements;
- Accesses into rear parking courts which should be located opposite to the fronts of dwellings in order to provide overlooking of the access;
- One public entrance into a parking court, to be used by both vehicles and pedestrians;
- Parking courts which are required to be well lit and achieve appropriate BS standards. Ground level lighting should be provided;
- Designing the boundaries of houses that abut parking courts to be a maximum 1.5 metres high with an additional 300 mm visually permeable trellis on top in order to aid surveillance.

- 4.33 Rear parking courts must be designed so that the resident's parking space is located on the boundary of the rear garden. In this way residents are more likely to use the parking court, rather than parking in inappropriate locations (e.g. on verges and footways).
- 4.34 All homes must be accessible from the rear through lockable gates that can be opened by means of a key from both sides. Paths need to be provided within rear gardens, from the rear gate to rear door of the house, to enable ease of access through garden when it is wet.
- 4.35 Parking courts should generally be within the range of 6-12 spaces. Larger courts may be appropriate for apartments. Tandem parking will not be allowed, as vehicles tend to dominate the court and the amount of vehicle manoeuvring is increased.
- 4.36 Rear parking courts should remain private and therefore visitor parking is not allowed within parking courts unless the parking court is ungated and under the control of some form of management company.
- 4.37 Garages and car ports should be avoided within parking courts as they block surveillance of vehicles.
- 4.38 Illustrative plans and photos are shown in Figure 6.

Figure 6 - Illustrations for rear parking courts



"Bridge over unit" makes a clearer definition that the rear court is private



Only one entrance for vehicles/pedestrians is permitted. Unlocked alleyways will not be permitted.



Secure rear parking court



Rear parking courts must be secure and not "leaky"

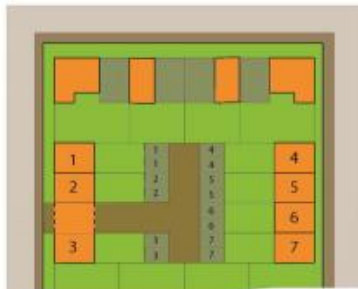

Resident's parking located on the boundary of the rear garden

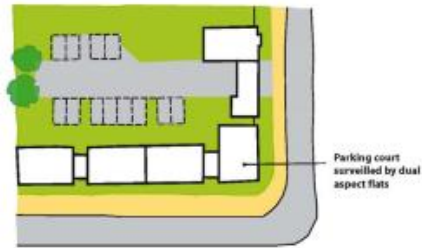

Rear parking court serving apartments



Plans showing FOPs used to screen and protect rear parking courts

On Street Parking

4.39 On-street parking should be built into the layout design and should be clearly defined, through use of different surfacing materials, kerbs, street furniture and/or planting.

4.40 On-street parking has several benefits, including:

- Assisting with speed restraint as part of an overall package of elements that together affect driver behaviour;

- Adding vitality to the street;
- Acting as a buffer to pedestrians on the footway from passing traffic;
- Making efficient use of land, as the street provides the means of access and parking spaces are shared.

4.41 Lay by parking should be provided in groups of 3-5 spaces. If there are more than 5 spaces in a row, they should be broken up by landscaping.

4.42 Parallel parking can either occur adjacent to the carriageway or within the carriageway as shown in Figure 7. When they are located within the carriageway, they can assist with speed restraint. Some form of feature is required at each end of the parking to ensure that the speed restraint effect remains when the car is absent. Consideration does however need to be given to the visibility of such street furniture and planting at night.

Figure 7 - Parallel parking arrangement



4.43 When locating parking on-street however, this will need to be appropriately designed considering the width and nature of the road in terms of traffic flow and speed. Parking should not encroach into the paths of vehicles.

4.44 In order to encourage more on-street parking and reflect where Milton Keynes residents like to park, the Residential Design Guide outlines three more innovative, less conventional, ways of providing parking on street which it is hoped developers will build into their layouts.

'Parking Streets'

4.45 Developments should include carriageways wide enough to allow parallel parking on both sides with space between for two cars to pass. Street trees within the pavement will reduce the visual impact of parked cars.

4.46 It has often been a challenge to fit in on-street parking spaces when numerous detached and semi-detached houses are included in a layout because of the requirement to accommodate and keep open private drives onto the carriageway. Individual parking bays are generally not supported where the footpath diverts its alignment continually to get around them. However, the sketch shown in Figure 8 indicates that where wider 'Parking Streets' are incorporated into a development, individual parking bays can be incorporated between driveways with the footpath remaining on its existing alignment. Two designs can result: either a tree can be included at the front and back of each parking space; or the parking spaces can be delineated with a different material. In both cases, but particularly the former, the features still result in traffic calming if the cars are absent.

Figure 8 – Parking Streets

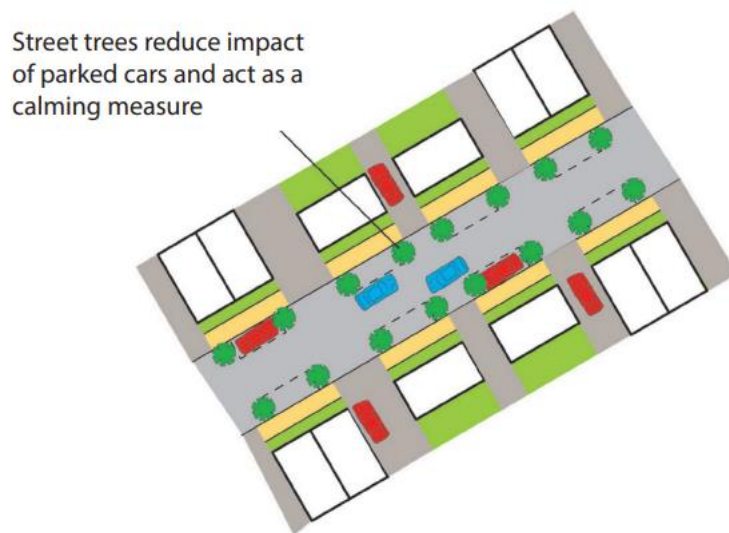

Public Squares

4.47 Public squares have the benefit of incorporating parking within a space which can also provide townscape and recreational benefits. The square can be used to provide parking for residents within an adjacent busier street. In more formal layouts, parallel parking can be arranged around a landscaped central space, which could be in the form of a square or circus, as demonstrated in Figure 9. In more informal layouts, parking can be provided within a predominantly hard-surfaced space.

4.48 Public squares must be designed into the layout at the master-planning stage – it is not advisable to try and retrofit them into a layout at a later stage.

Figure 9 – Public Squares



Example of formal public square layout accomodating parking around its edge

Central Reservations

4.49 Parking can be provided within a central reservation with cars arranged both sides of a strip dividing traffic flows. Landscaping should be provided to reduce visual impact. A good example of this approach is shown in Figure 10.

Figure 10 – Parking at Central Reservation



Parking in the central reservation - Oxley Park

Figure 10 cont. – Parking at Central Reservation

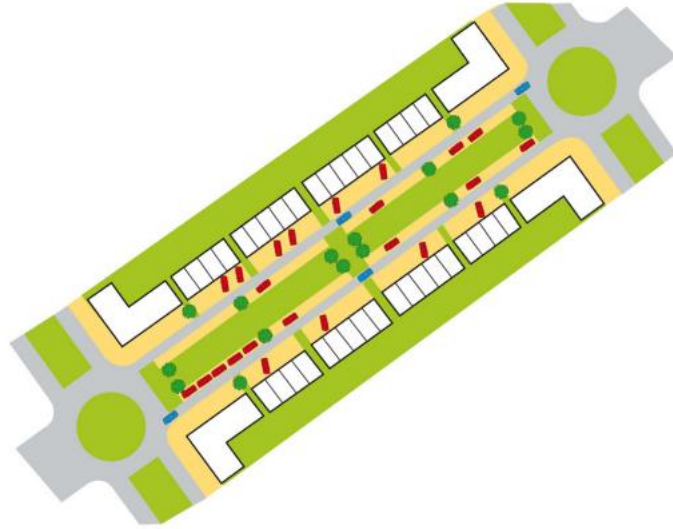

5. Parking for Non-Residential Uses

- 5.1 Many of the principles discussed above are equally applicable to non-residential uses.
- 5.2 More applicable to the latter however will be off-street car parks. These should be designed to provide good quality pedestrian routes in order to minimise conflict between those walking through the car park and manoeuvring vehicles.
- 5.3 Where multi-storey or underground car parks are provided, these should be designed in accordance with the usability specifications outlined in relevant industry guidance such as the Institution of Structural Engineers 'Design Recommendations for Multi Storey and Underground Car Parks' (2011)¹³. This includes guidance on issues such as the positioning of columns which would affect the usability of a space and therefore whether it will be considered as a parking space when an application is determined.

¹³ [Design recommendations for multi-storey and underground car parks \(Fourth edition\) - The Institution of Structural Engineers \(istructe.org\)](http://www.istructe.org)

6. Cycle Parking Design

- 6.1 Cycle parking needs to be considered at the outset and long-term storage for residents and employees should be within a covered, lockable enclosure. For individual houses, this could be in the form of a shed or garage. For flats and non-residential uses, either individual lockers or cycle stands within a lockable, covered enclosure are required.
- 6.2 Cycle parking should be located close to entrances and where it is indoors, the user should not need to pass through more than one door. Stairs should be avoided and where there is a change in level between the cycle store and ground level, lifts should have a capacity for a bicycle without the need for it to be raised up.
- 6.3 Short term cycle parking should be in a prominent location close to site and / or building entrances and may need to be provided in multiple locations. It may be possible in some instances to utilise the public highway, though this would need to be sympathetic to the positioning of other street furniture and ensure that footway widths are maintained.
- 6.4 Cycle parking should be secure, easily accessible and convenient to use. Although the Council does not prescribe a particular type of stand, those located on the highway (for example to provide for visitors) should be consistent with existing provision. Within buildings, upright stands are not favoured as the need to lift bikes makes them more difficult to use, and indeed, may be impossible for some users. Systems which only allow one wheel to be secured will also not be supported, though innovative space saving solutions such as two-tier racks, which are more practical to use, will be considered.

7. Other Vehicles and Parking Layout

Powered Two-wheelers

- 7.1 Parking standards for powered two-wheelers / motorcycle / Moped for developments at all zones will be sought based on the figures provided in Table 3.
- 7.2 With reference to IHE guidance¹⁴, the key elements for parking are that it should be: near, clear, secure and safe to use.
- 7.3 Motorcycle users will naturally look for parking opportunities as close as possible to their destination. 20 metres is desirable. Beyond 50 metres the use of unofficial space can become prevalent. Formal parking spaces should be clearly marked and signed to highlight them to users.
- 7.4 Security is a key issue and physical measures are highly sought after and attractive to users, as is natural surveillance. Covered off street parking is desirable as it provides protection from weather and damage. Storage areas for clothing and equipment should also be provided.
- 7.5 As with all types of parking, personal security and safety is highly important to encourage use. Things to consider are a level surface to move the machine around on, lighting, CCTV and natural surveillance.
- 7.6 Individual spaces should not be marked in order to make the most efficient use of the available space. Most machines range from 700mm to 1000mm wide. Allowing for a nominal mount/dismount space of 600mm suggests that an average width of 1400mm per machine is required. Where there is significant use by smaller or larger machines, this figure can be altered to suit.

All types of non-residential development	Provision
GFA of 1000 m2 or more	A minimum of 2 spaces with anchorage points, 1 space per 70 total car spaces.
Minor Developments GFA below 1000 m2	Case by case.

¹⁴ [Motorcycle Parking - IHE Guidelines for Motorcycling \(motorcycleguidelines.org.uk\)](https://www.motorcycleguidelines.org.uk/)

Size of Parking Spaces

Layout for standard car parking bays

- 7.7 It is noted that, in the 2001 Highway in Residential and Commercial Estates Design Guide, the introduction of variation in width, alignments, etc, as a design feature, can result in pleasing and attractive layouts. However, flexibility is not acceptable at the expense of safety.
- 7.8 Standard parking spaces should be a minimum of 5 metres by 2.5 metres (Diagram 1). Where the parking space adjoins a wall/fence (Diagram 2) or dwelling (Diagrams 3 & 4), additional space should be provided.
- 7.9 For parking courts and car parks, an access road in between bays should ordinarily have a minimum width of 6 metres when bays are orientated at 90 degrees. Where such a width is not achieved, the width of parking bays will need to be widened to compensate for this as detailed in Manual for Streets. It is recommended that tracking software be used to assist in the design of car parking and that diagrams be included within Transport Statements, particularly for sites where space is constrained.
- 7.10 Parking for those with disabilities should measure a minimum 6.1 metres by 4.7 metres where access is possible to the rear (e.g. perpendicular to the kerb), incorporating a safety zone around each side and the rear of the space. See Diagram 5 taken from A Highway Guide for Milton Keynes¹⁵.
- 7.11 Providing accessible parking in an arrangement parallel to the kerb is not preferred, but in situations where it is, the parking space should be extended by 1.2 metres to allow an access zone to the rear of a vehicle. All disabled parking should preferably be located within 50 metres of the entrance to the building it is serving in accordance with the Department for Transport's Inclusive Mobility guidance¹⁶.

¹⁵ [A Highway Guide for Milton Keynes 2018](#)

¹⁶ [Inclusive mobility: making transport accessible for passengers and pedestrians - GOV.UK \(www.gov.uk\)](#)

Diagram 1 – Standard parking space

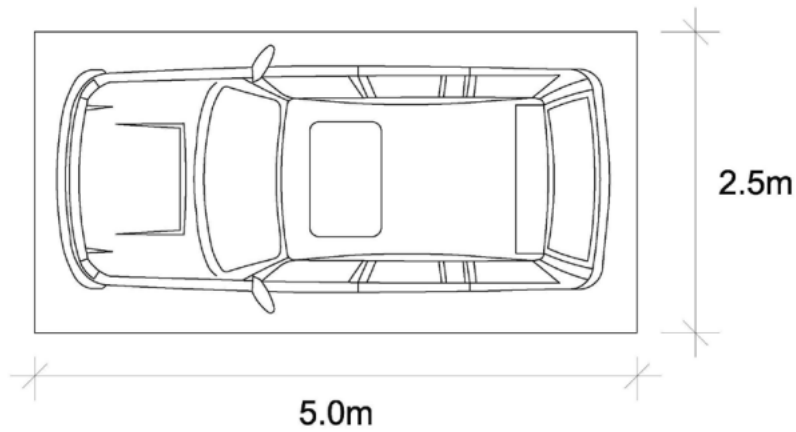

Diagram 2 - Space adjoining a wall/fence

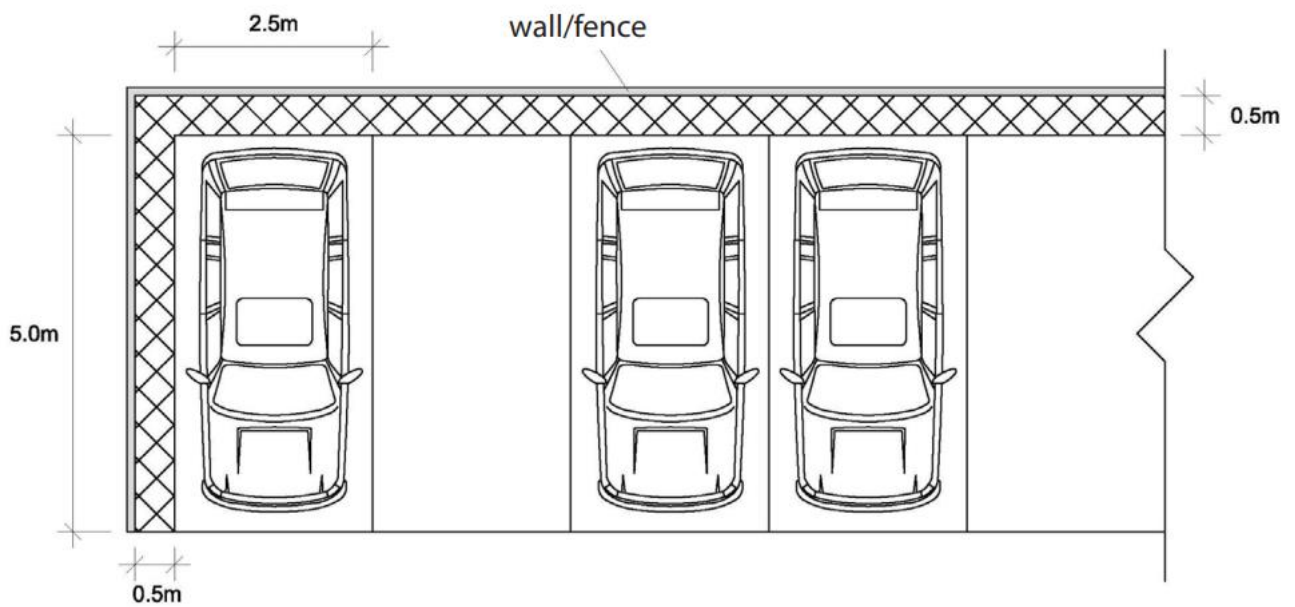
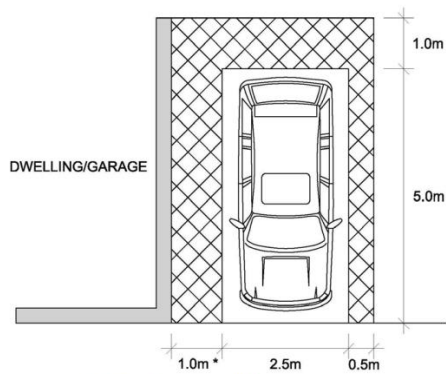

Diagram 3 - Parking space adjoining a dwelling/garage



* 1.0m if required for access to rear of dwelling. Can be reduced to 0.5m if no access is required.

Diagram 4 - Parking space adjoining a dwelling/garage

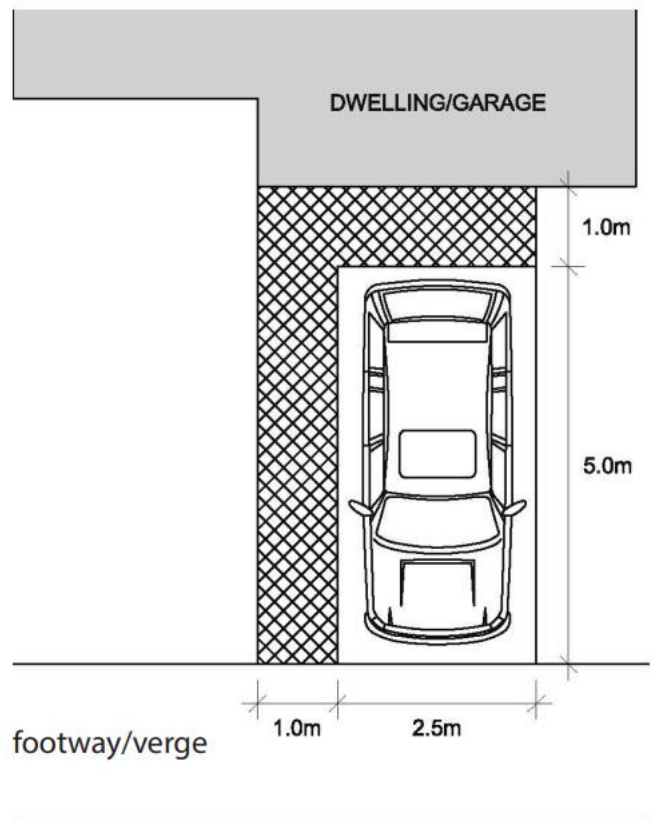
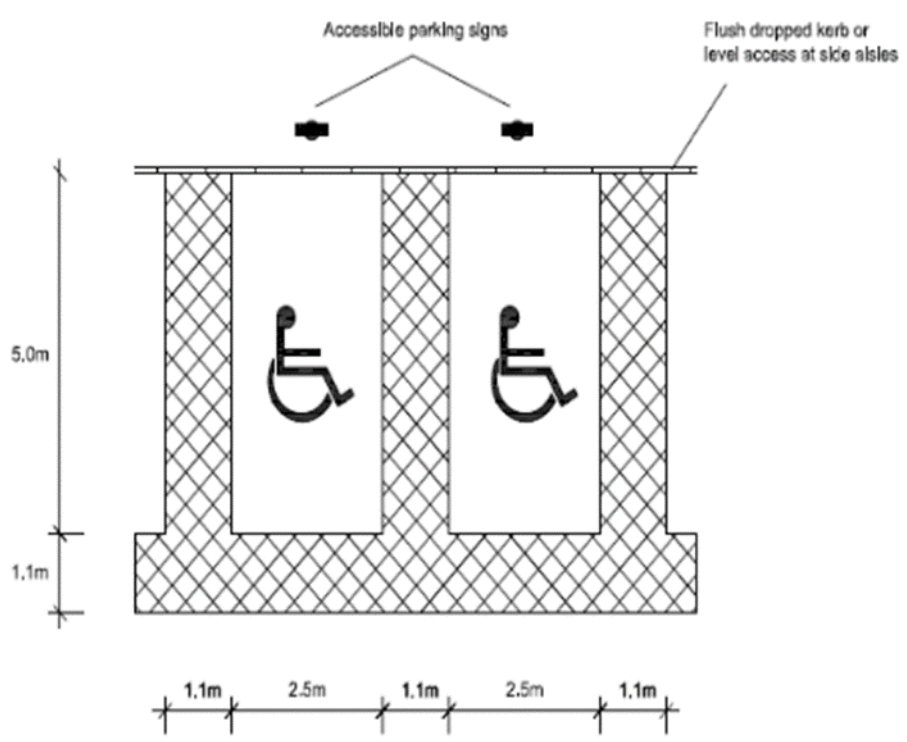
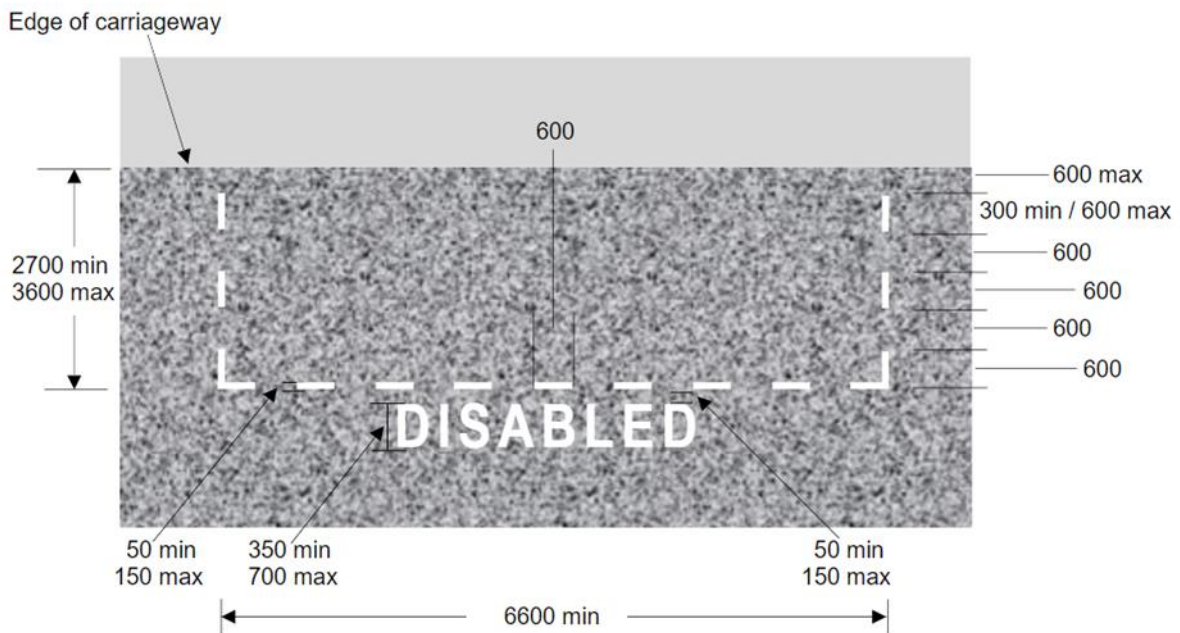

Diagram 5 - Off-Street parking for people with disabilities



7.12 Providing accessible parking in an arrangement parallel to the kerb is not preferred, but in situations where it is, the parking space should be enlarged to be a minimum of 2.7m x 6.6m. See Diagram 6 taken from A Highway Guide for Milton Keynes. All disabled parking should preferably be located within 50 metres of the entrance to the building it is serving in accordance with the Department for Transport’s Inclusive Mobility guidance.

Diagram 6 - On-Street parking parallel to a kerb for people with disabilities (Note: Layout must include a disabled parking sign)



7.13 Note, at least 1 active EV charging bay in non-residential developments will be required to be an enlarged bay, and at least 5% of total EV (active and passive) bay provision.

Layouts for Service vehicles and HGVs

7.14 Parking provision for service vehicles and HGVs has been identified for all Business, General Industrial, Storage and Distribution land uses within Milton Keynes. All other land uses are considered on a site-by-site basis to allow flexible approach to development, which reflects the differing land use profiles and highway characteristics throughout the authority.

7.15 Spaces allocated for deliveries, service vehicles, HGVs, coaches, buses and minibuses should be capable of accommodating the expected vehicle type as predicted in the Transport Assessment. Where pick-up / drop-off is in a designated bus bay set into the kerb / footway, or immediately between designated car parking areas on the highway, adequate allowance must be made for entry and exit taper.

7.16 Principally the preferred parking bay size for these vehicles should be used as set out in Table 5.







	Bay Dimension	
	Length	Width
Transit/Van	7.5m	3.5m
Rigid	12.0m	3.5m
Articulated	17.0m	3.5m
Coach	15.0m	4.0m
Minibus	8.0m	4.0m

7.17 Further Guidance is contained within the Logistics UK (formerly known as Freight Transport Association) publication 'Designing for Deliveries'¹⁷.

¹⁷ [Designing for Deliveries | FTA Shop \(logistics.org.uk\)](https://www.logistics.org.uk/resources/publications/designing-for-deliveries)

Appendix A – Maps of Parking Standards Zones

Legend

Legend	
Zone 1	
Zone 2	
Zone 3	
Zone 4	
Zone 5	
Borough Boundary	
Zone Undecided	

Whole Borough Accessibility Zones Map

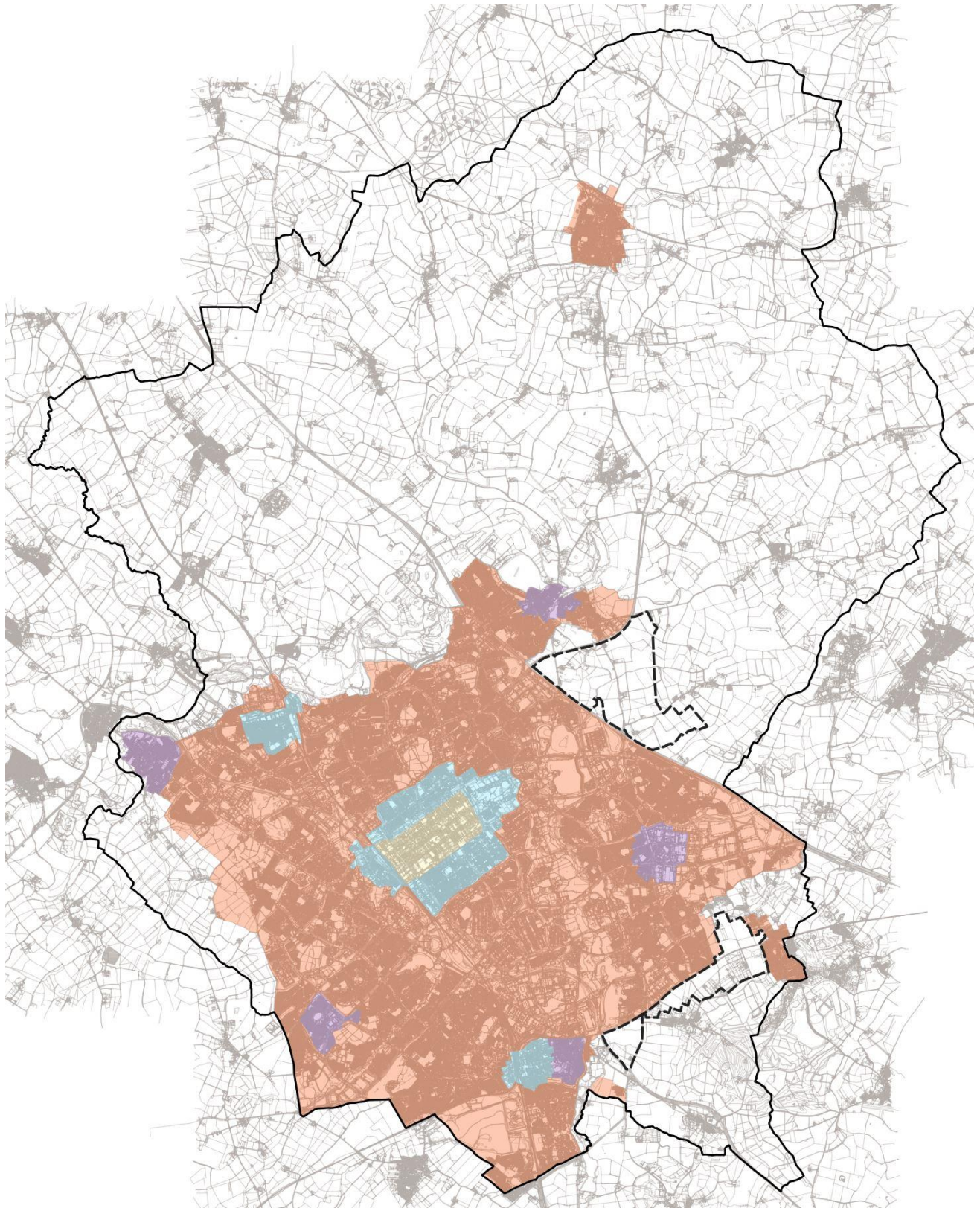

City of Milton Keynes Accessibility Zones Map

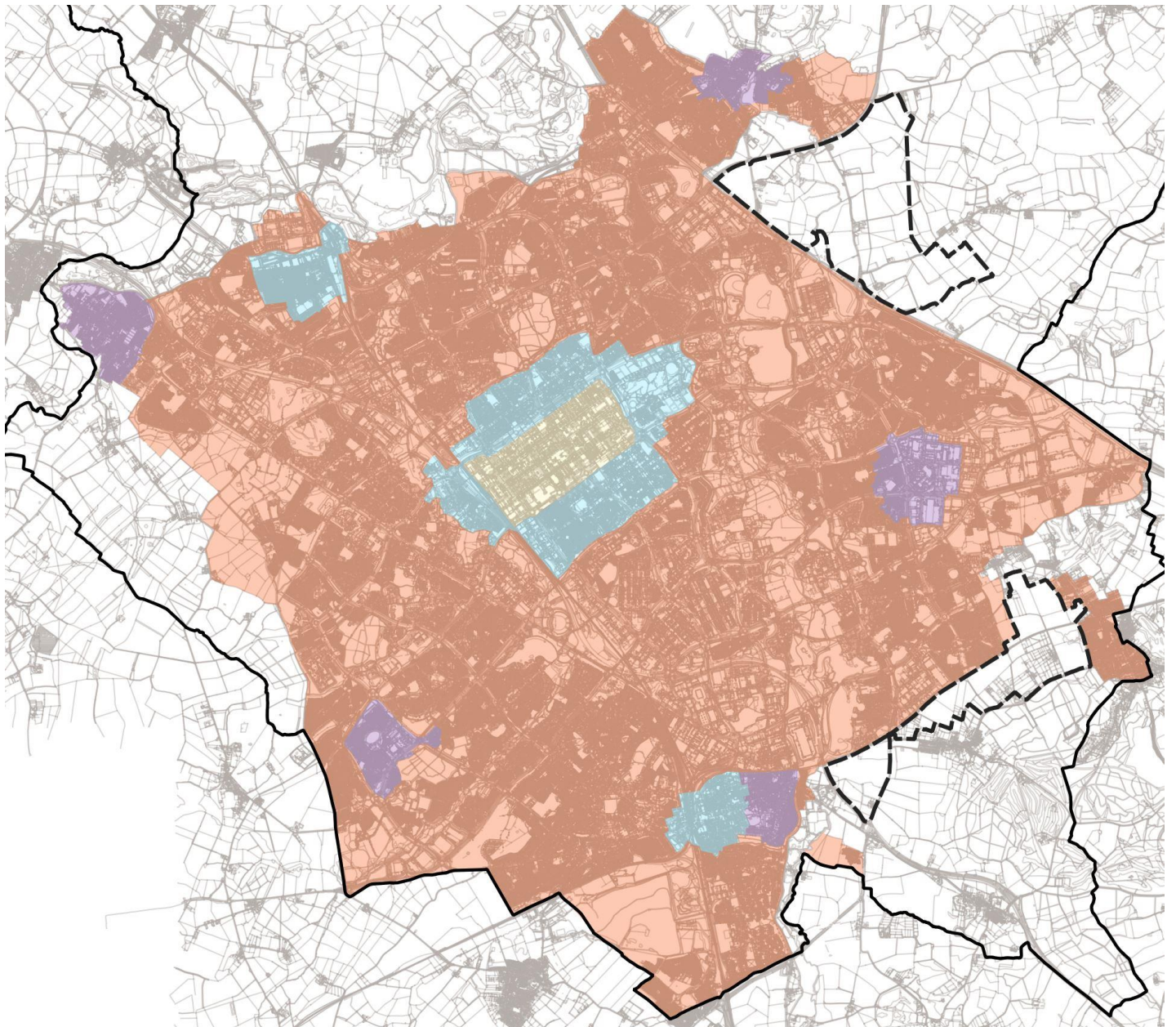

Wolverton Accessibility Zone 2 Map

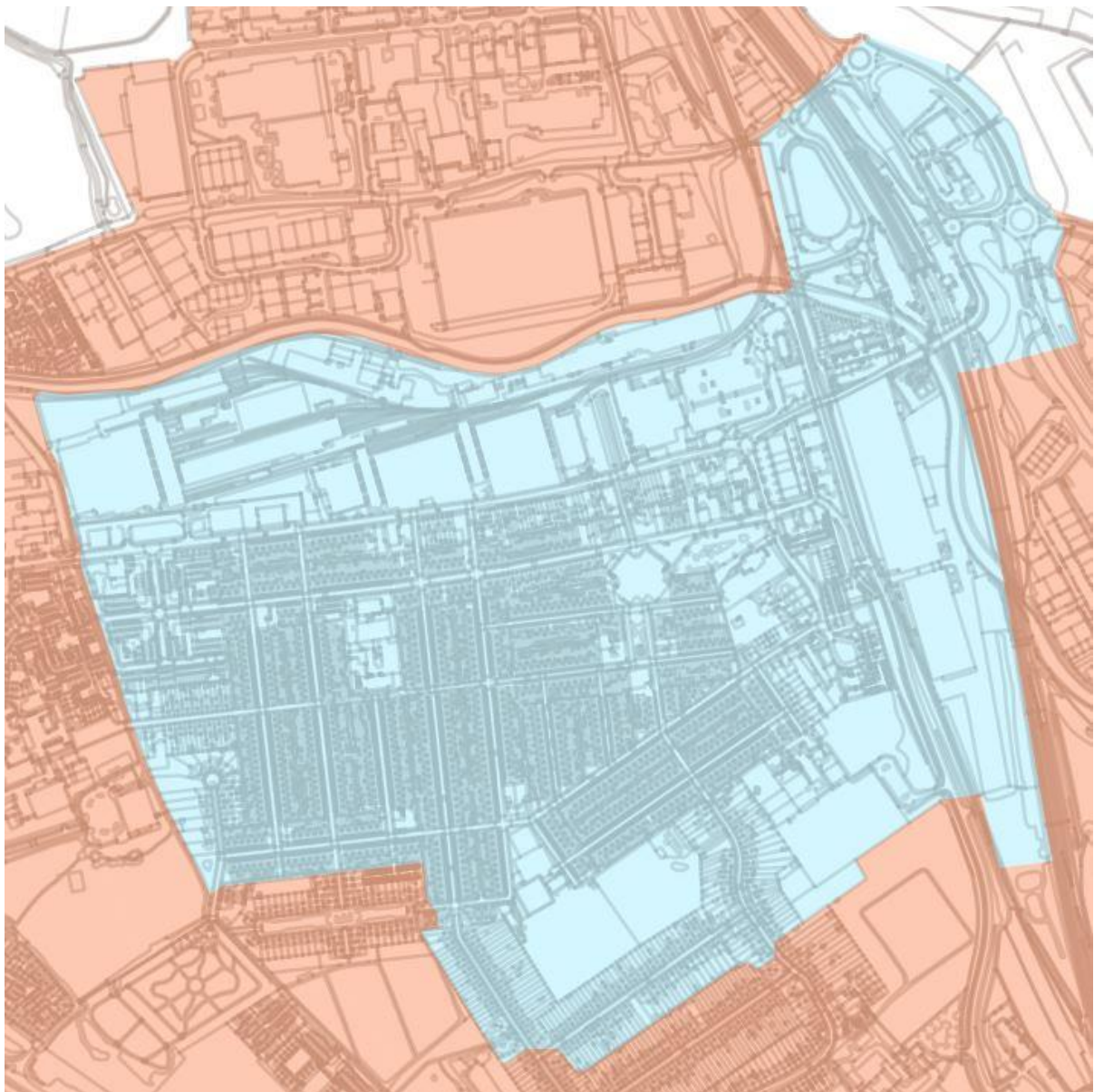

Bletchley and Fenny Stratford Accessibility Zone 2 and 3 Map

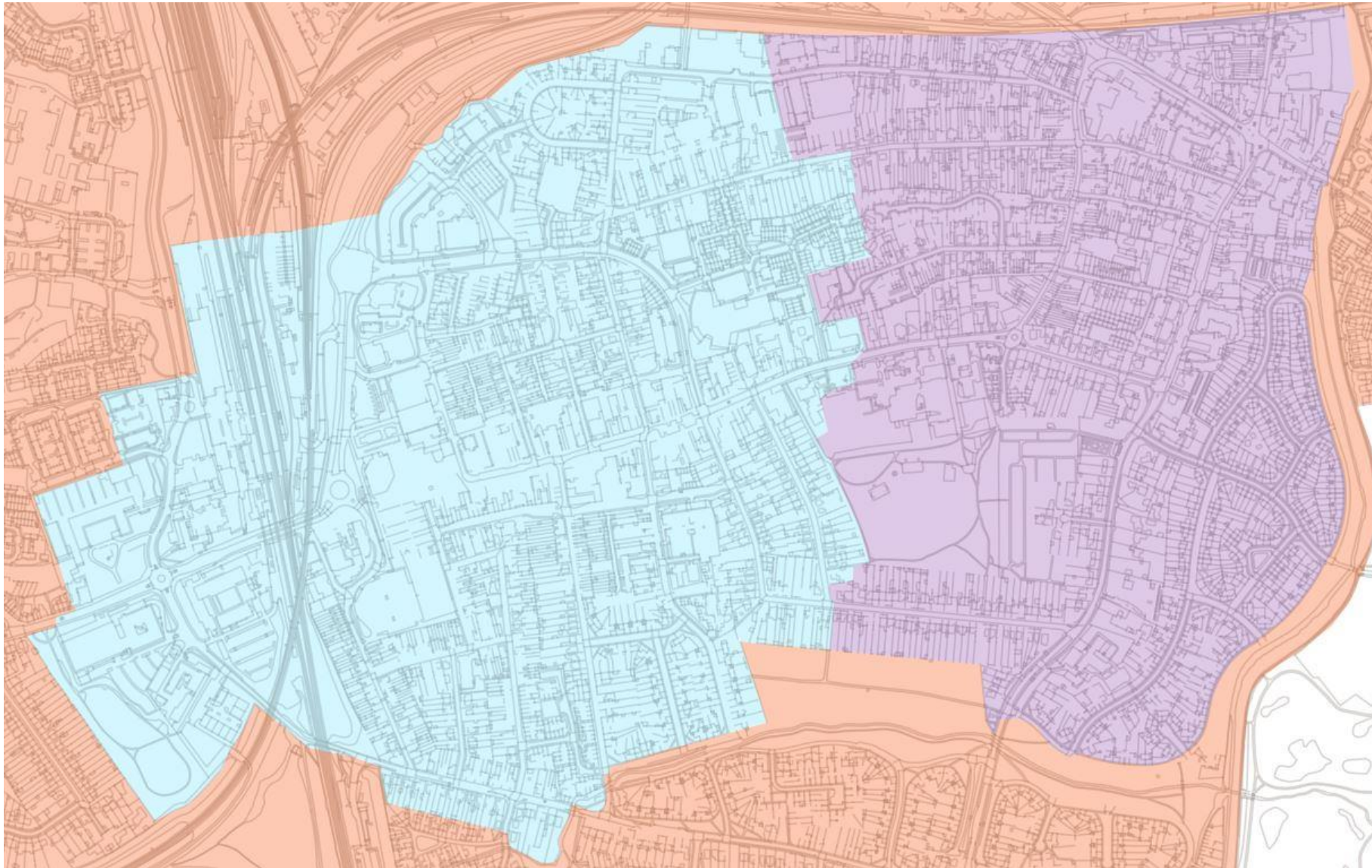

Newport Pagnell Accessibility Zone 3 Map

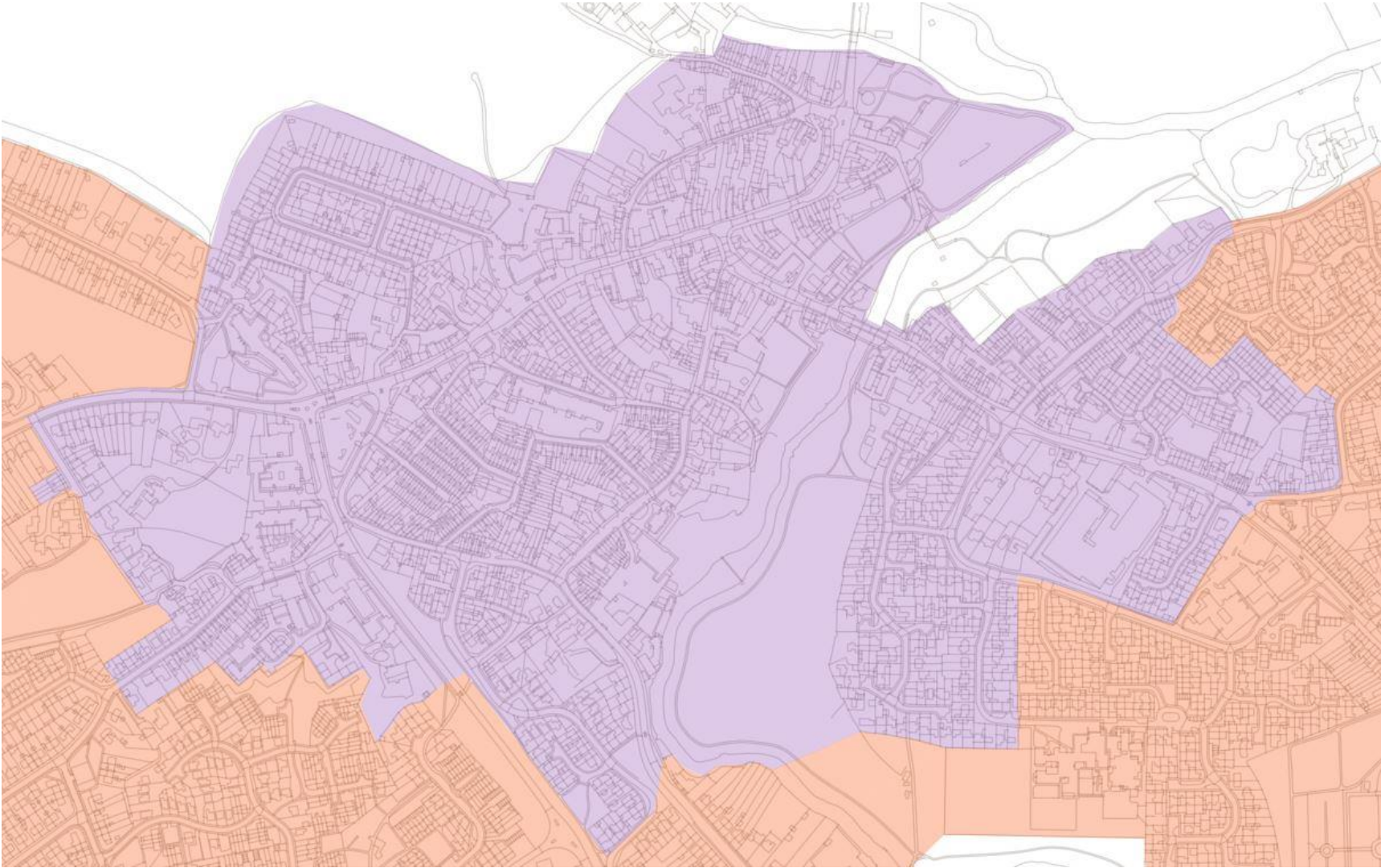

Stony Stratford Accessibility Zone 3 Map

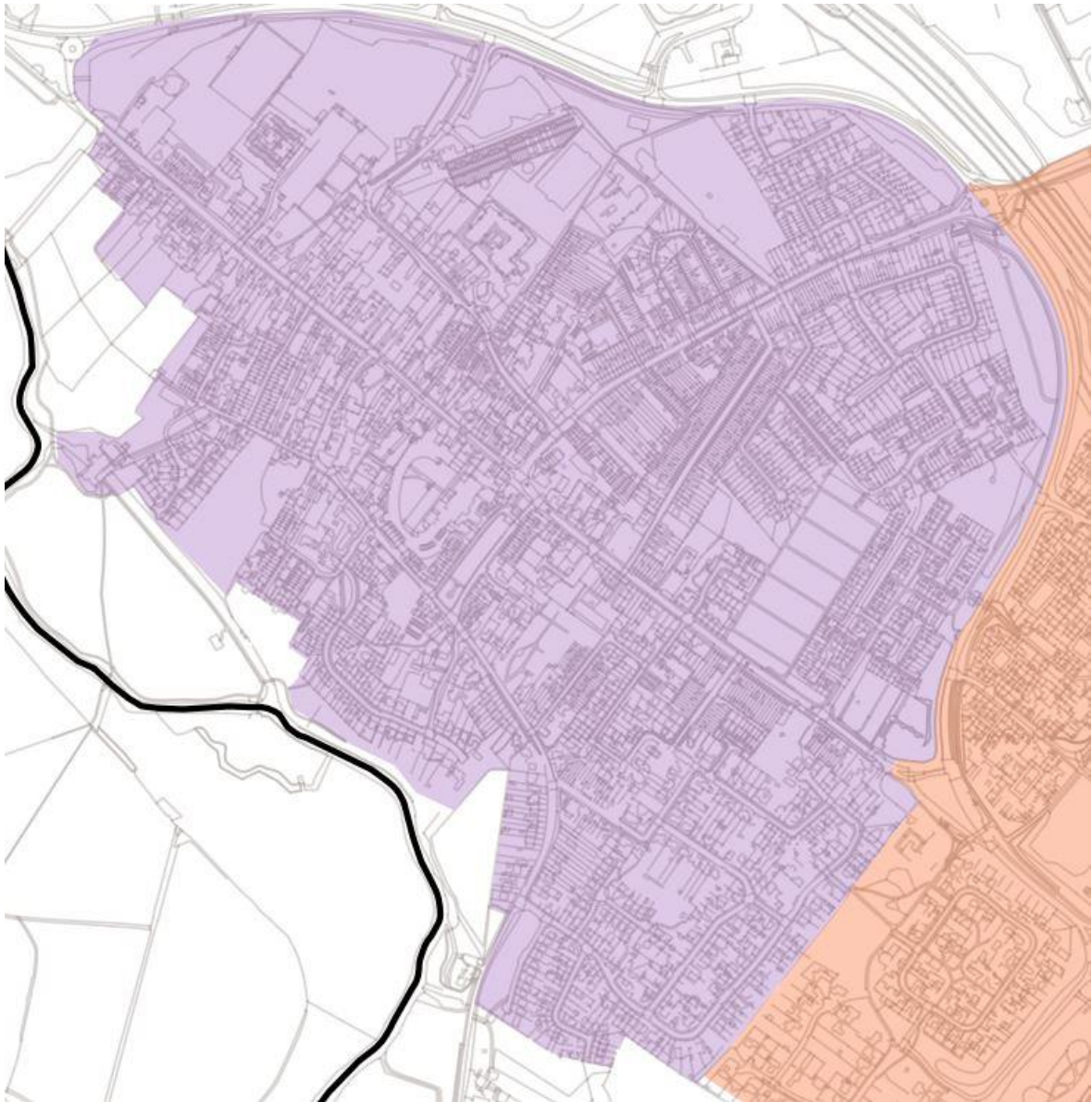

Westcroft Accessibility Zone 3 Map

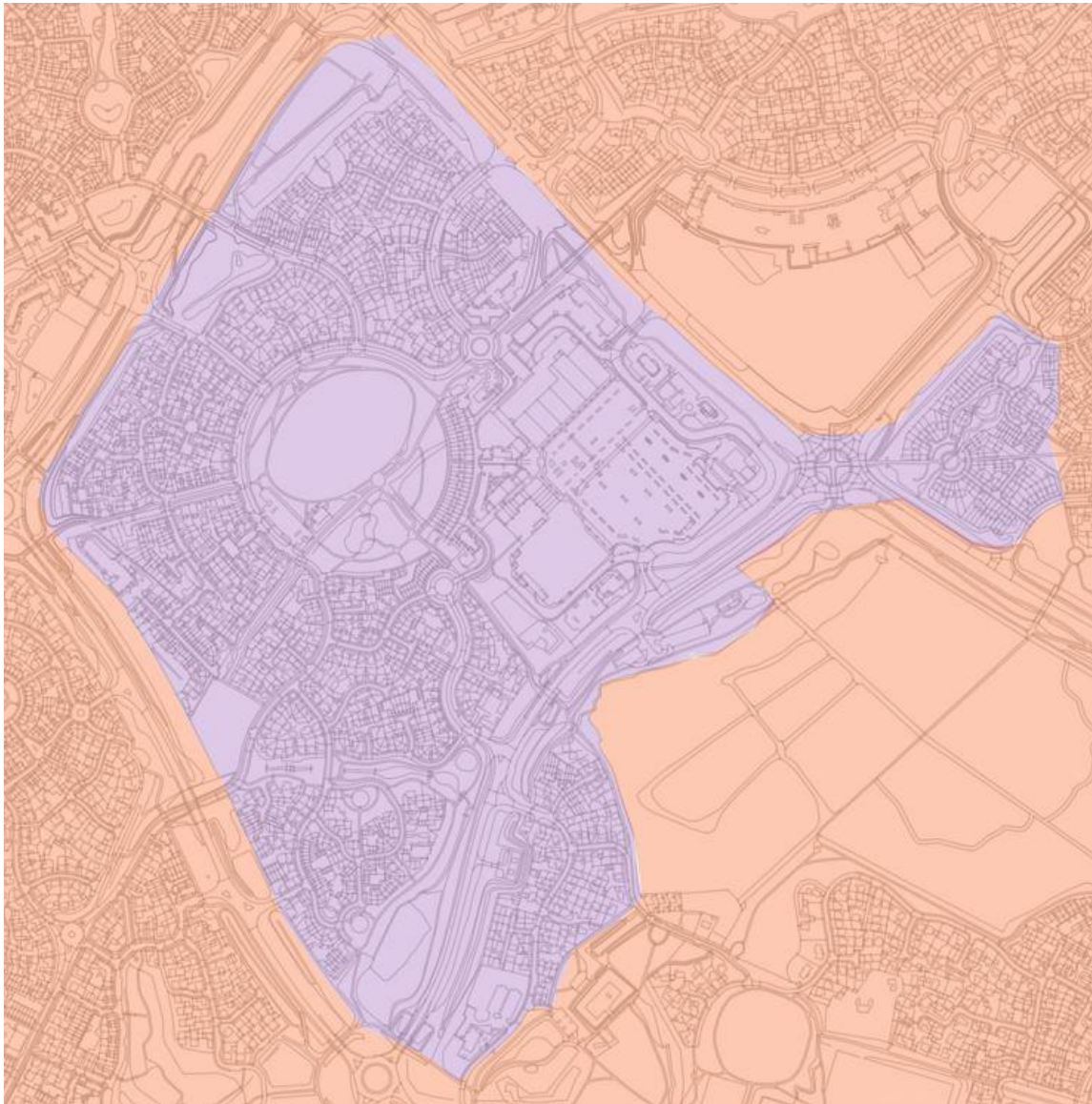

Kingston Accessibility Zone 3 Map

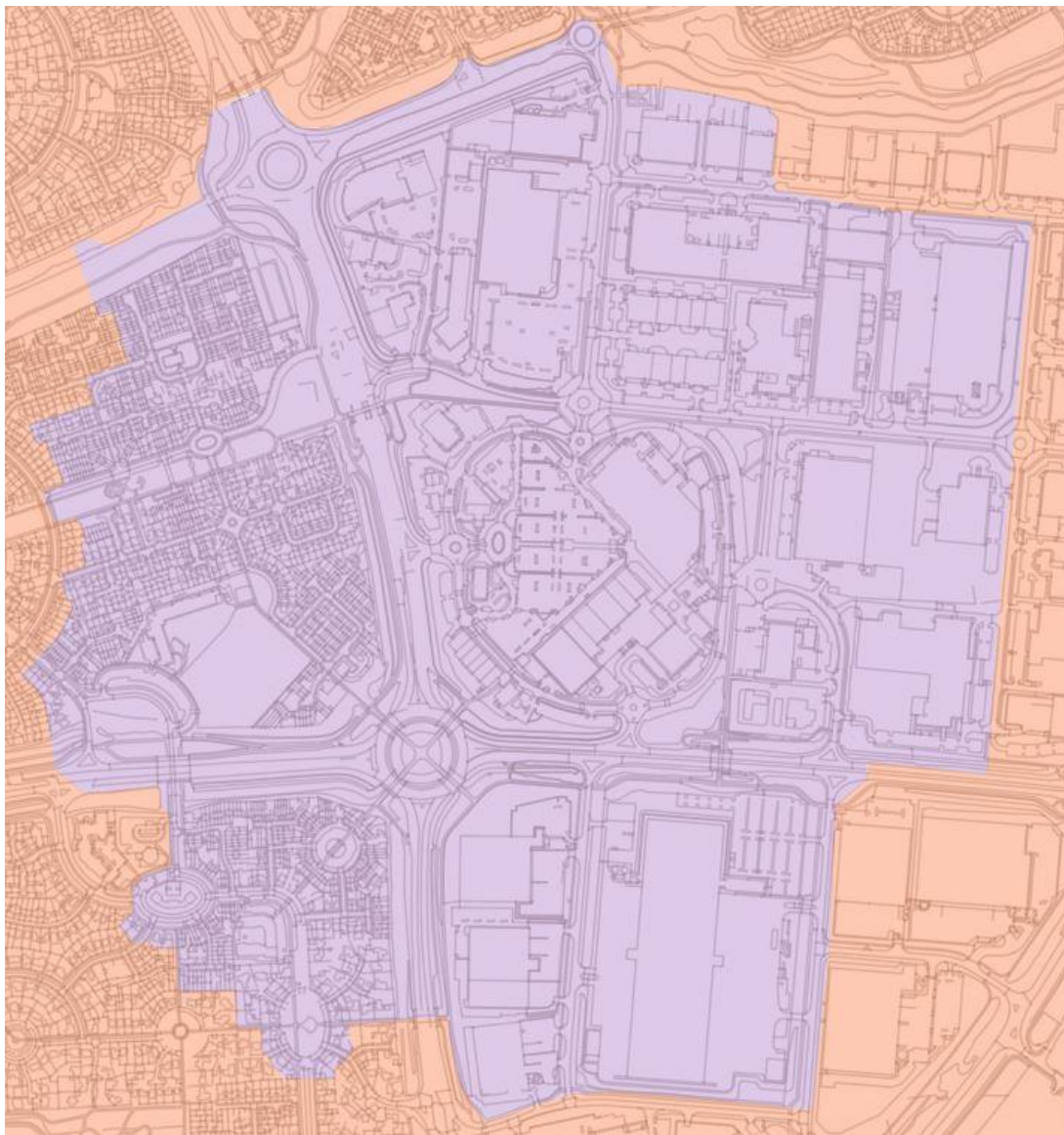

Olney Accessibility Zone 4 Map

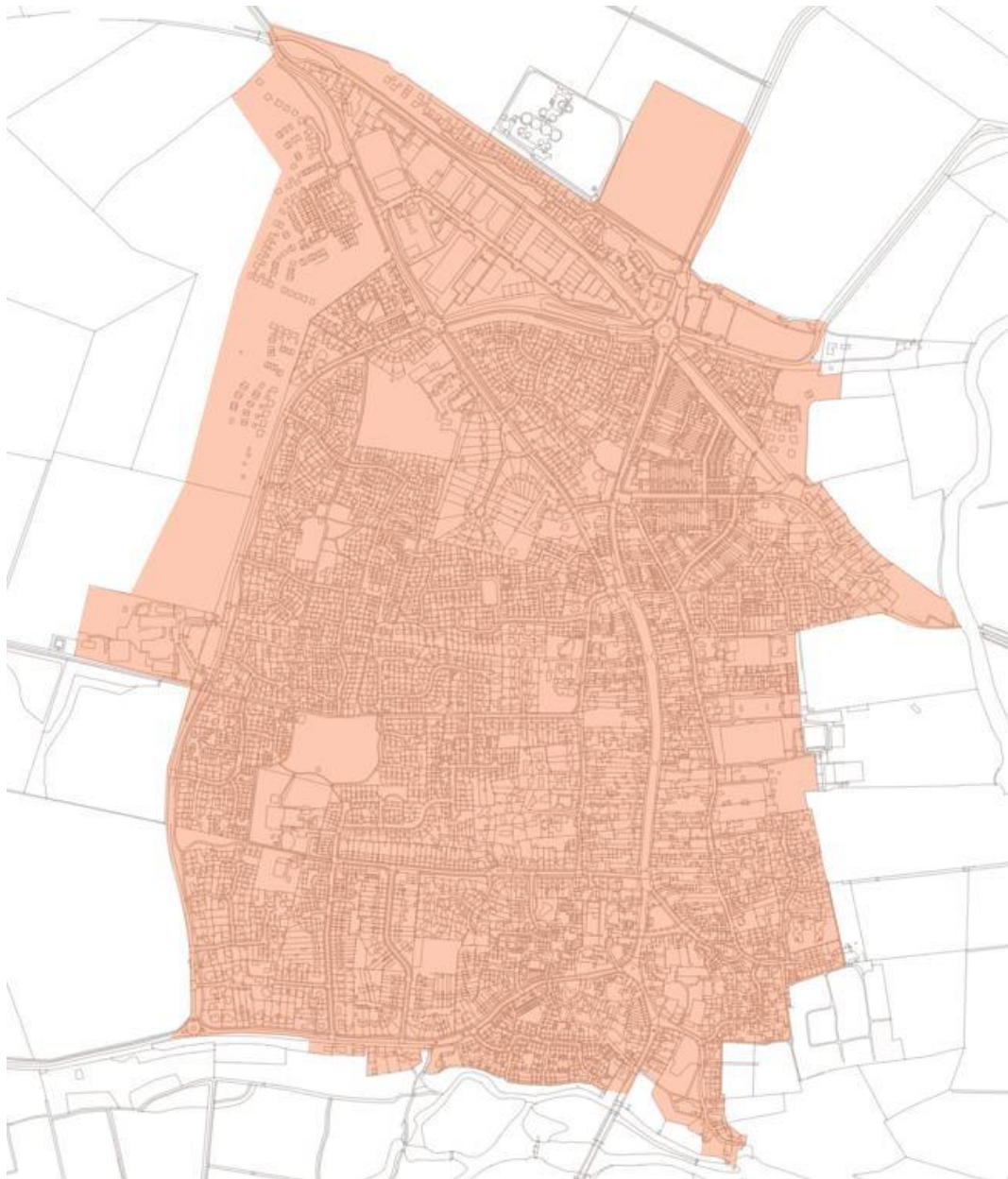

Woburn Sands Accessibility Zone 4 Map

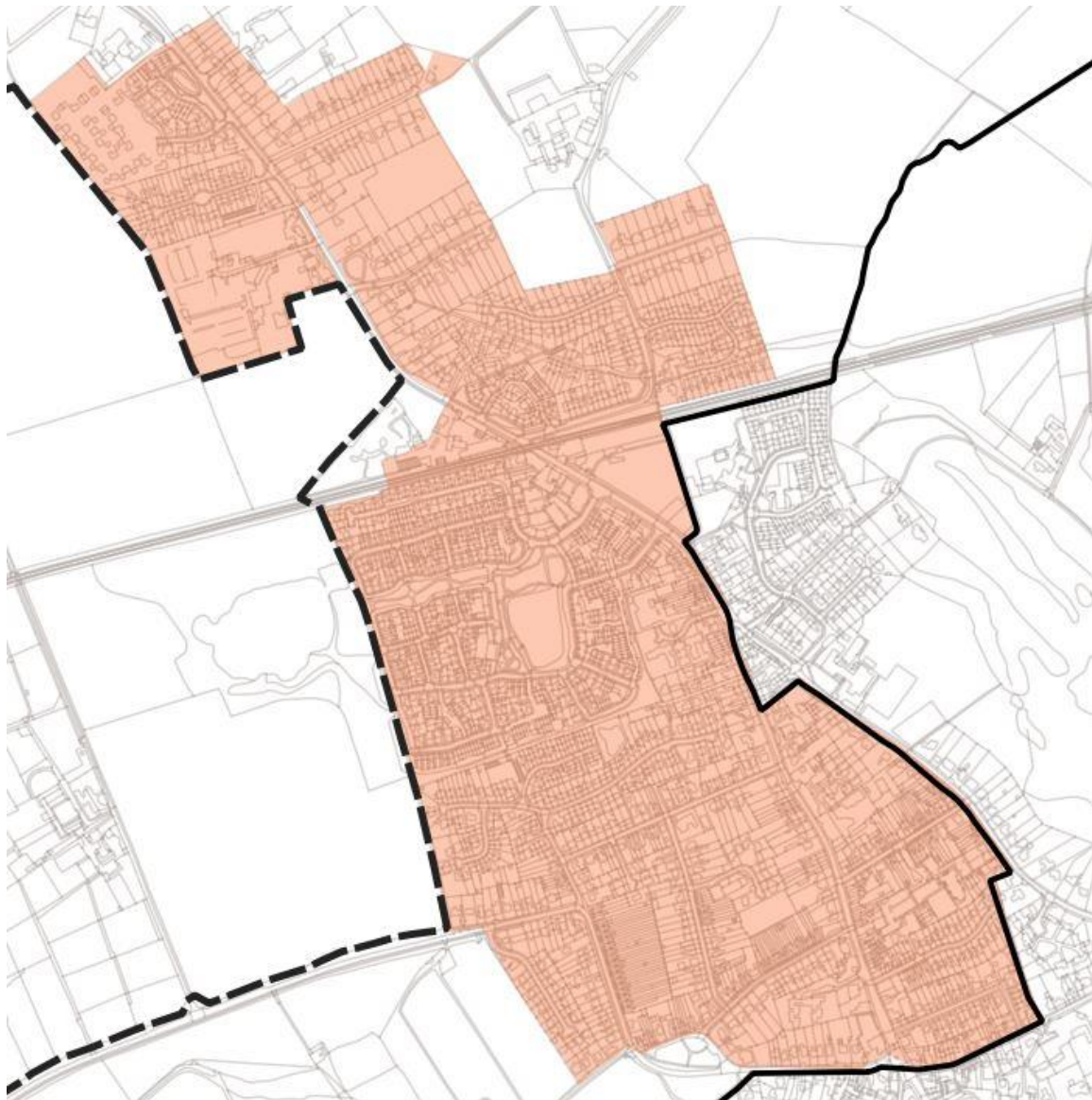

Eaton Leys Accessibility Zone 4 Map

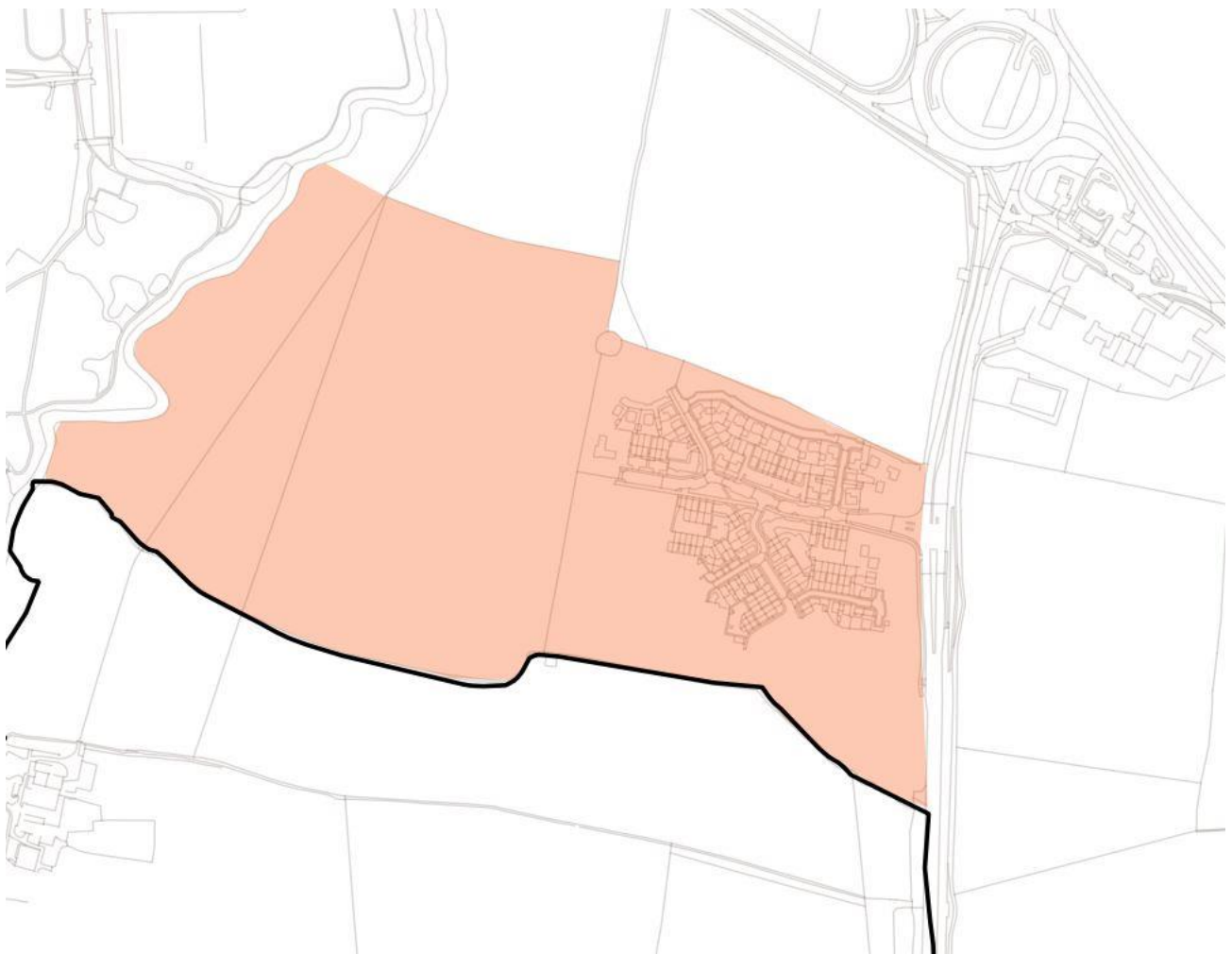

Milton Keynes East Strategic Urban Extension Map

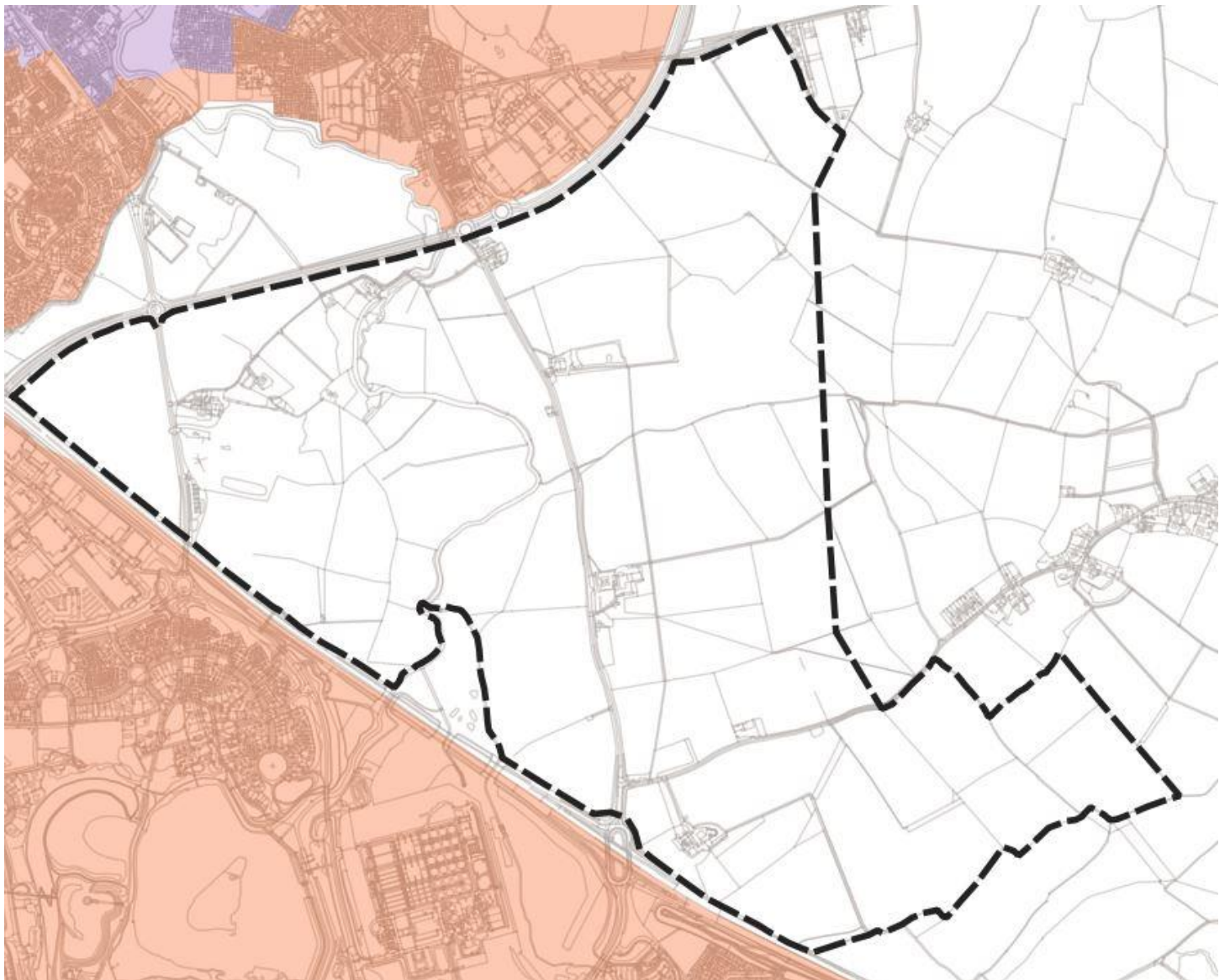

South East Milton Keynes Strategic Urban Extension and South of Milton Keynes Strategic Employment Allocation Map

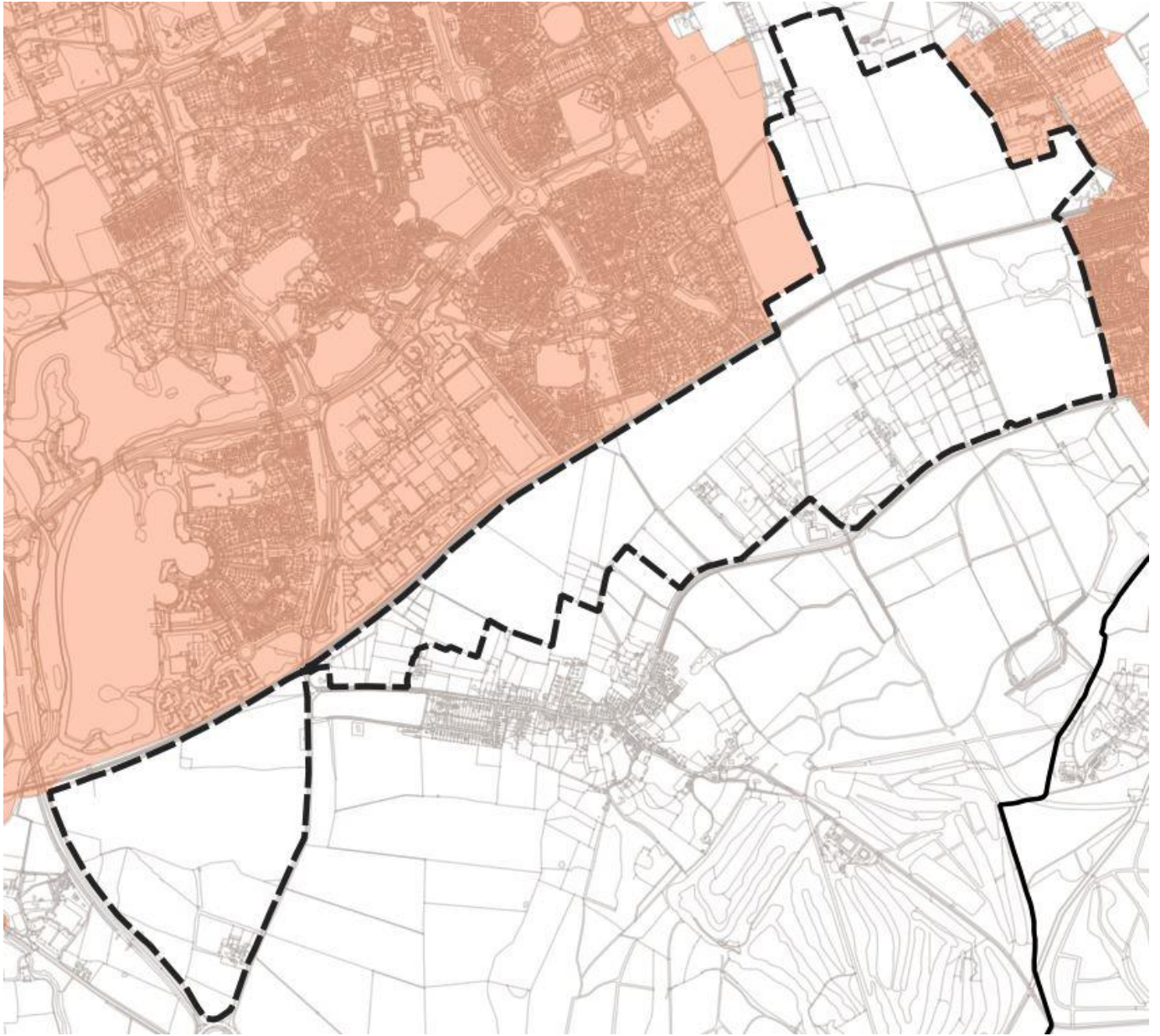

Appendix B - Guidance Note: Implementing Car Clubs in New Development

Introduction

1. Pay-per-trip car clubs, sometimes known as car sharing, allow individuals and businesses to have access to a personal vehicle without having to own a vehicle. Pay as you go cars offer affordable, occasional access to cars as and when required by the user. As explained in the main body of the SPD, in some circumstances, car clubs are an accepted way to support lower than standard car parking provision in new developments¹. This guidance note explains our position on how car clubs should be implemented.

Car Clubs in New Developments

2. So that their benefits are maximised, car clubs should be accessible not just to users of new development, but to everyone in the local area. Ideally, car club markets cater to a mix of residential and commercial customers. This will help ensure maximum use from the vehicles and will support long-term car club viability. Car clubs should therefore be promoted to prospective occupants (off-site), in welcome packs and periodically post-occupation. Incentives such as free membership and drive time can help people to form new travel habits at a moment of change in their lives. Promotional activity should be included within the coverage of a travel plan.
3. We strongly advise the early involvement of a car club operator(s) in the decision about whether and how to facilitate access to, or provide, a car club for occupants of a development proposal and local area. Evidence of how a car club service provided by a development would function, and details of prior engagement, will need to be included within planning application submissions.
4. Car clubs should be promoted to prospective occupants (off-plan), in welcome packs and periodically post-occupation, coupled with incentives such as free membership and drive time can help people to form new travel habits at a moment of change in their lives. Promotional activity should be included within the coverage of a travel plan.
5. We will expect the developer to contribute to the start-up and/or longer-term running costs of the car club. For example, if an existing car club company is chosen by the developer to run the car club provided by the proposal, the contribution could take the form of paying for the car club vehicles. However, we recognise that developer agreements with car clubs often vary in scope. Therefore, provision of residents' car club memberships and/or contributions to car clubs will be secured on a case by case basis through use of planning

condition(s) and or a legal agreement, such as a Section 106 agreement, as appropriate to the form of car club provision. This reflects the evidence base produced by Project Centre as well as best practice guidance by CoMoUK².

6. If a car club already exists close to the site of a development proposal, rather than provide another car club within the site, an acceptable solution may be for the developer to contribute to the expansion of the nearby club, subject to agreement of the car club operator and the Local Planning Authority. Any such expansion would need to be at a scale equal to the size of the development proposal and likely amount of car club use generated by occupants of the development. This approach would likely be better suited to smaller developments, as the evidence base work for this SPD indicates that isolated standalone car club vehicles are rarely viable.

Design Considerations

7. Care must be taken in the siting of, and access to, car club vehicles, to ensure people have full-time access to the vehicles without impediment. For example, car clubs should not be in private enclosed parking areas, if shared with people from outside the development.
8. Consideration must also be had to additional statutory obligations regarding car club spaces located in the highway such as Traffic Regulation Order³ and Traffic Signs Regulations and General Directions⁴.
9. As some car club operators use remote systems to monitor the locations, starts and stops of car club vehicles, consideration should be given to the mobile/GPS network accessibility of the chosen parking area. As above, developers should therefore discuss with car club operators, early in the design process, how a car club would work for users in practice.
10. Clear and enforceable marking of car club bays are important, with signing that raises awareness of and promotes the car club to potential customers.

Accreditation

11. Using accredited car club providers is a way to ensure a high-quality car club. Accreditation ensures that a collectively agreed set of standards are upheld across the industry to maintain the reputation that these shared transport schemes have gained as a valuable component of sustainable transportation. CoMoUK is an example of a car club accreditation scheme.
12. Where connection into a car club is relied upon for reduced parking provision in any development in the borough, it must be an accredited car club.

Appendix C – Guidance Note: Electric Vehicle Charging and Parking

Policy CT6 in Plan:MK requires new developments to support the roll out of electric vehicles in the borough and is the key policy on this topic.

Policy CT6: Low Emission Vehicles

- A. The Council will maximise the use of sustainable transport in developments, and support low carbon public and personal transport such as electric cars and buses.
- B. The Council will require new facilities for low emission vehicles to be integrated into new major development schemes where local centres are proposed.
- C. All new developments will be required to provide electric charging points in line with standards set out in the Milton Keynes Parking Standards.
- D. Rapid and fast charging points will be located throughout Milton Keynes as well as at key locations including Central Milton Keynes, employment sites, railway stations, major retail and visitor destinations, outside schools, local centres and car parks.

1. This section sets out in part how we expect electric vehicle (EV) charging facilities will be provided within new developments. We recommend this guidance is read in conjunction with the Milton Keynes Council Parking Standards contained in the main body of this SPD or subsequent updated versions to this, which contains other requirements for EV charging facilities provision and when active vs. passive EV charging point provision should be installed.
2. The following sub-sections cover: the different types of EV charging points available; information about charging point suppliers; which types of EV charging points are better suited to different development types and situations; charge point accessibility; feasibility considerations during design; considerations for car parking layout when providing EV charging points.

Types of Electric Vehicle Chargers

3. There is a range of electric vehicle chargers available in the UK from an ever-growing number of suppliers. The units fall into two physical types: wall mounted and free standing.

4. Wall mounted units are generally associated with lower powered systems based upon a either a single-phase electricity supply and charging at 3.6-kW or 7-kW, or a three-phase electricity supply and charging at 11-kW of 22-kW. Wall mounted units come with either a single or twin Type 2 socket. They can be provided with several alternative access control systems if required. Wall mounted units can be supplied with open, or lockable sockets, or with tethered cables and plugs.
5. Floor standing posts are also available for lower powered systems again based upon a either a single-phase electricity supply and charging at 3.6-kW or 7-kW, or a three-phase electricity supply and charging at 11-kW of 22-kW. Floor standing units come with either a single or twin Type 2¹⁸ socket. They can be provided with several alternative access control systems if required and can be fitted with a guard post to prevent damage from vehicles. Floor standing posts are available in a variety of diameters and colours.
6. Rapid chargers and ultra-rapid chargers are generally much larger units and will be supplied with tethered cables. These larger units may be subject to planning permission due to their height, though some units have been designed to fall within the envelope of equipment that does not need planning permission in the UK. Most rapid and ultra-rapid chargers are supplied with a number of tethered cables to suit a range of vehicle types. They can often provide either DC or AC charging to suit different vehicle types. The power range for this class of charger range from 50-kW DC / 43-kW AC to 350-kW DC.
7. Most electric vehicles can be charged from a standard domestic three-pin socket and most vehicles are supplied with a standard EVSE (electric vehicle supply equipment) charging cable for this purpose. These cables enable charging at around 2.3-kW and are only appropriate for charging over long periods of time when there is no EV charger available. However, use of long extension cables in conjunction with EVSE chargers is discouraged due to several safety and security concerns which include trip hazards and electrical safety. Therefore, provision of a three-pin socket for charging an EV vehicle due to the requirements in Policy CT6 in Plan:MK would not be acceptable.

Suppliers of Electric Vehicle Chargers

8. There are an increasing number of charge posts available in the UK as new and established providers vie for part of the anticipated electric vehicle charging market. The most comprehensive source of charge posts and charge post providers can be found at the UK

¹⁸ "Single" or "twin Type 2" refers to the different shaped sockets and plugs available in the market for electric vehicle charging systems. While some charging points come with a range of tethered cables to suit different socket/plug types, the market does enable consumers to buy socket/plug adapters to suit their individual needs. Type 2 sockets are the standard connector for EV cars across Europe.

Government’s Office For Low Emission Vehicle’s (OLEV) website¹⁹, where a list of charge posts that are approved for government grant funding can be found for both residential and commercial charge post installations.

- The OLEV list of approved home charge units should be used as a guide to all residential installations in Milton Keynes, in order that these residential installations may benefit from any available grant funding schemes.

Different Chargers for Different Locations

- As above, there are several types of charger which are available on the market which provide a range of power capacities to suit different applications. These chargers can be considered in four groups:

Slow Charging	Generally, 3-kW	Suitable for overnight charging / home charging
Fast Charging	7-kW and 22-kW	Suitable for vehicles which are parked for more than 1 hour
Rapid Charging	43-kW and 50-kW	Suitable for vehicles which are stopped for only 20~30 minutes
High Power Charging	150-kW and 350-kW	Emerging technology being deployed to enable ‘filling station’ type charging during short duration stops

- The following paragraphs outline the types of EV charge points we expect new developments to provide, following on a use and location-based approach. It is important to note that approximately 95% of daily journeys are within the range of most electric vehicles and the average daily mileage is only 31 miles. This indicates that many electric vehicles do not need to be charged every day. Parking Assessments/Plans submitted with planning applications should demonstrate consideration of the following guidance to explain how the EV provision and parking management reflects the trip generating characteristics of the proposed use.

Residential Dwellings and Houses in Multiple Occupation

- For new houses with access to dedicated off-street parking we expect that 3-kW charge posts/wall mounted chargers are provided. In some cases where the power supply allows, 7-kW charge posts/wall mounted chargers could be installed. For new houses with adjacent off-street parking, we expect that wall chargers connected directly to the residential consumer unit are fitted.

¹⁹ <https://www.gov.uk/government/organisations/office-for-low-emission-vehicles>

13. Houses in Multiple Occupation, on the basis that many electric vehicles will not need to be charged each day, should provide a 3-kW charger(s) on the understanding that residents would share the charge point(s) at the property as required.

Hotels and Secure/Non- Secure Residential Institutions

14. Hotels and all types of residential institutions are subject to the non-residential buildings EV parking standard in Table 1. Due to the wider variety of likely users and varied visit times these users will have, should provide a mix of 7-kW to 50-kW chargers.

In-Centre Office Developments or Schools/Day Centre/Nursery in Parking Zones 1-3

15. For new city/town-centre-based offices or schools, days centres or nurseries at any location with their own dedicated parking, it is likely that there will be three possible use cases.

- Employees who spend the day in the office or school, day centre or nursery. For this use case 3-kW and 7-kW chargers would be appropriate, if commute distances warrant charging at work.
- Employees who come to the office and then use their cars for business trips. For this use case 7-kW and 22-kW chargers would be appropriate, but consideration should be given to 50-kW chargers if daily mileages warrant rapid charging.
- Visitors. For this use case a 7-kW charger would be appropriate as a courtesy if there are no public chargers nearby.

Out-of-Centre Office Park Developments in Parking Zones 4-5

16. The initial choice for an out-of-town office park will concern whether to provide a central charging 'hub' to be shared by all users of the office park, or whether to install charging infrastructure at individual 'units'. For use cases associated with individual units the descriptions outlined above for offices in city/town-centres will provide guidance.

17. Where a central charging hub is proposed, we expect a mix of 7-kW and 50-kW²⁰ units. Where 50-kW chargers are adopted, mechanisms may need to be put in place to prevent vehicles which are not charging preventing other users gaining access to the charge post (see below guidance on EV parking management).

Retail and Leisure Uses (including restaurants and gyms)

²⁰ It should be noted that most 50-kW chargers will provide 43-kW AC output and 50-kW DC charging.

18. Retail and leisure parks can generally be assumed to have common parking areas which serve the whole park. Generally, there are two categories of customers on these parks; those who quickly visit one specific retail store and those who stay for a few hours – either to visit several stores, to eat or to visit leisure facilities.

- Electric vehicle drivers who go to a retail park to visit a specific store are unlikely to be there for enough time to make use of an electric vehicle charger.
- For other visitors to out of town complexes containing a range of retail, leisure and potentially F1 and F2 use class uses, charges provided by 7-kW and 22-kW chargers are expected, to provide sufficient power for drivers to obtain a usable range and thereby providing an attractive reason to visit that particular location. Higher power chargers could also be installed at these locations to support electric vehicle owners who are stopping for a short space of time during a longer journey.

19. Where individual units are proposed, a mix of 7-kW to 22-kW chargers is expected. Over the course of the lifetime of the development, such uses would likely have a variety of visit times due to differing tenant requirements should tenants change, and different uses and events take place. For example, if the site is a museum or exhibition hall, we can reasonably expect visit times to be longer than at a supermarket. Regard here is had to recent changes to the Use Classes Order²¹ and the wide range of potential uses buildings could accommodate over their lifetimes.

Research and Development, Any Industrial, Distribution and Storage Uses

20. In general, the likely type of charging units required for staff and customers of research, industrial, distribution and storage units will be the same as those for offices depending on whether they are in or out of city/town centres. There may be some additional requirements for charging vehicles in a workshop environment and where a flexible solution is required, the adoption of overhead power rails with movable charge points may provide a suitably flexible solution.

Community Charging Hubs

21. Community charging hubs are growing in popularity and are a means to provide electric vehicle charging facilities in existing communities where there is little or no off-street parking and where kerb-side charging is difficult to arrange. Hubs are best located in areas which also provide additional facilities such as cafes and convenience stores. This is because hubs are intended for drivers who will need to charge their vehicle before returning to their normal

²¹ <https://www.legislation.gov.uk/uksi/2020/757/made>

place of parking and are not intended for long-term parking, while also providing drivers with an opportunity to group car trips to local services and facilities, encouraging more sustainable travel patterns.

22. Hubs should provide a mix of 7-kW fast and 50-kW rapid chargers to address the growing concerns about charge post availability. Ultra-fast charging hubs which include chargers with powers up to 350-kW could be provided. However, the location of such hubs will require careful consideration due to the power demands for multiple ultra-fast chargers which may involve reinforcement of the distribution grid.

Sui Generis

23. The type charging point provision for sui generis uses will be decided on a case-by-case basis, using the above requirements as a guide but also considering site specific circumstances such as the expected number of users and duration of visits.

Electric Vehicle Charge Point Accessibility

24. Access to charging points is a decision which is the prerogative of the site / electric vehicle charge point owner. However, for public posts which are to be installed with the help of a grant from OLEV, we expect that, as per 2018 Automated and Electric Vehicle Act, the post should be available for pay-as-you-go customers and that the post should have 'smart' functionality. Access controls can include RFID card readers, simple key locks and remote unlocking via an app, or phone call to the back-office provider.

Feasibility and Standardisation Considerations

25. Power availability is a key factor when considering the installation of electric vehicle charge points. The amount of available power and the location of the distribution board relative to the proposed charge post locations will need to be considered at the feasibility stage.
26. For developments involving the change of use of an existing building, the site's electrical capacity and usage will be available from the site's electricity invoices. In other cases, it may be necessary to consult with the building's facilities team in conjunction with a review of the building's distribution board in order to determine the site's capacity to accommodate different types of EV chargers.
27. The unit cost of chargers and the cost of installation increases with the power supplied, with rapid and ultra-rapid chargers costing more than post and wall mounted units.

28. Interoperability is a prime consideration when planning which types of charging points are provided by a development. Planning applications in their Parking Assessments/Plans will need to demonstrate how, in choosing the means of providing access to a secured post, the developer has considered any other (public) charging schemes in the area. For the benefit and convenience of electric vehicle owners, new posts should be interoperable with most public posts in an area.

Parking Area Design

29. Planning applications will have to, where new parking is provided, include a Parking Assessment and Plan and this should include on a proposed block/parking plan both the layout of the proposed parking area and the location of any active/passive charging infrastructure required as per this document, or any subsequent updated versions.

30. As above, for new homes where on-site parking space is adjacent to the house, we expect a wall mounted charger to be used. This wall-mounted 'box' can provide a convenient socket, or alternatively wall boxes can be fitted with a tethered cable and suitable plug.

31. The design of parking areas and the provision of electric vehicle charging within a shared parking area should take account of the position of and the environment around the parking area. For an existing car park, the location of the power source is a prime consideration; positioning the charge posts as close as practicable to the power source will be the most economic option. Similarly, for new parking areas, the provision of a power source at a suitable point in the car park should be considered at the design stage. In most cases, the primary power supply will be connected to an electrical feeder pillar, which will include an electricity meter and from which the individual charge posts will be connected.

32. There is no common position for charging locations on cars or vans, so locating charge posts at the ends of parking bays where vehicles can be parked either forwards or backwards presents the most useful location. A post located at the junction of two bays can serve either of those two bays. If there is a suitable structure or wall adjacent to the parking spaces a wall mounted charge point 'box' can be adopted.

33. For installations involving multiple posts, in line with best practice we expect a maintenance contract to be put in place that includes a service level agreement with the post supplier, or other suitably qualified organisation to ensure the availability of the charging posts. Please provide information demonstrating this in the Parking Assessment/Plan accompanying your planning application.

34. Such arrangements should also consider EV parking management which is becoming an important topic as there are many instances of charge posts being occupied by either internal

combustion engine vehicles or by electric vehicles which are not charging. Enforcement can be a significant issue for rapid and ultra-rapid chargers, where the expensive asset needs to have a regular flow of users who stay only for a short time (circa 30 minutes). Electric vehicle charging bays should also be clearly marked to deter people using vehicles with internal combustion engines from using them.

35. There are commercial organisations who provide EV parking management services, which may be appropriate in some circumstances. Such organisations may use CCTV to monitor the use of marked electric charging bays and issue parking charge notices to unauthorised users of these bays. If an EV parking management service provider is to be used, we would advise that they are regulated by the British Parking Association and are a member of the Approved Operator Scheme, to ensure that quality and transparent services are provided.

Development Plans Team

Civic Offices

1 Saxon Gate East

Central Milton Keynes

MK9 3EJ

T: 01908 691691

E: Development.Plans@milton-keynes.gov.uk

